



STARMAX



Playgrounds • Outdoor gyms • Trampolines



*We like to train and play with children,  
which is why we produce the best playgrounds  
and sports equipment. Join us!*



# TABLE OF CONTENTS

---

<b>ABOUT US</b>	<b>3</b>
<b>SPECIAL MARKINGS</b>	<b>4</b>
<b>PLAYGROUNDS EQUIPMENT</b>	<b>5</b>
Themed playgrounds	6
Swings	19
Active play sets	20
Springers	21
Slides	22
Educational play panels	23
Recreation elements & sandpits	24
<b>OFK SERIES - OUTDOOR GYM DEVICES FOR KIDS</b>	<b>25</b>
OFK series devices for gyms	26
OFK series devices for playgrounds	29
<b>PLAYGROUND TRAMPOLINES</b>	<b>31</b>
Single trampolines	32
Trampolines sets	35
<b>OF2 SERIES - OUTDOOR GYM DEVICES ON POSTS</b>	<b>37</b>
<b>OF3 SERIES - OUTDOOR GYM DEVICES ON PYLONS</b>	<b>41</b>
Single OF3 devices	42
OF3 outdoor gym sets	47
<b>OFC SERIES - PREMIUM OUTDOOR GYMS ON PYLONS</b>	<b>49</b>
<b>OFM SERIES - PREMIUM OUTDOOR GYMS ON POSTS</b>	<b>54</b>
<b>STREET WORKOUT EQUIPMENT</b>	<b>58</b>
Street workout sets	59
Single workout devices	63
<b>SOME OUR PROJECTS</b>	<b>66</b>





## ABOUT US

**STARMAX** is a team of enthusiasts trying to change the world for the better. For fifteen years we have been promoting the creation of public places for physical activity, recreation and outdoor fun.

Introducing the new catalog where you will find our classic series of products and a whole range of new products. Let our ideas inspire you to create stunning and safe recreational spaces in your neighborhood. Based on our own production experience and thousands of implementations, we are

expanding our offer with new products of the highest quality, so that you can find something special for yourself.

Through an extensive distribution network, we reach the farthest corners of the map, popularizing the **STARMAX mission** - physical activity and rest in urban space available to everyone. We are successful in what we do because we are open to cooperation and new ideas. Now we are waiting for your project.

**Marek Starczewski**  
Co-Founder & CEO



## SPECIAL MARKINGS

This catalog has been designed with your convenience in mind. For this reason, we have developed a special marking system for the technical parameters of our products listed in the catalogue. The individual special designations with descriptions are shown below.

 <b>S</b>	<b>Performance standards</b>		<b>Safe area dimensions</b>
	<b>Device dimensions</b>		<b>Free fall height</b>
	<b>The area of the safe zone</b>		<b>Execution standard</b>
	<b>The most popular product in the series</b>		<b>Inclusive device</b>

## GUARANTEE



We guarantee 10 years for the strength of structural steel parts and stainless steel elements.



5 years for the strength of elements made of HDPE and HPL boards, corrosion resistance of elements made of stainless steel, hot-dip galvanized steel and powder coated.



3 years for the durability of elements made of glued wood, plastic and rubber, powder-coated black steel.

**WE CREATE THE  
WORLD OF  
OUTDOOR  
PHYSICAL  
ACTIVITY**







## PLAYGROUNDS

### Performance standards: "P", "I", "W", "WI"

- **P** - Premium steel galvanized and powder coated steel structure, plywood or HDPE platforms, side panels and HDPE roofs
- **I** - Inox stainless steel structure, HDPE/HPL platforms, side panels and HDPE/HPL roofs
- **W** - Premium Wood construction made of glued timber, galvanized and powder coated steel elements, HDPE/HPL platforms, HDPE/HPL side panels and roofs
- **WI** - Inox wood glued wood construction, stainless steel elements, HDPE/HPL platforms, HDPE/HPL side panels and roofs

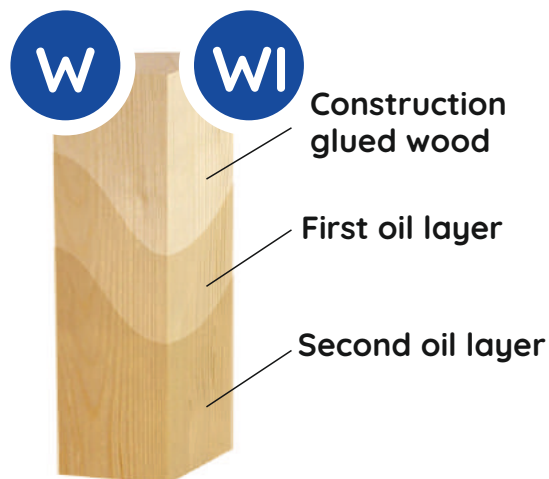
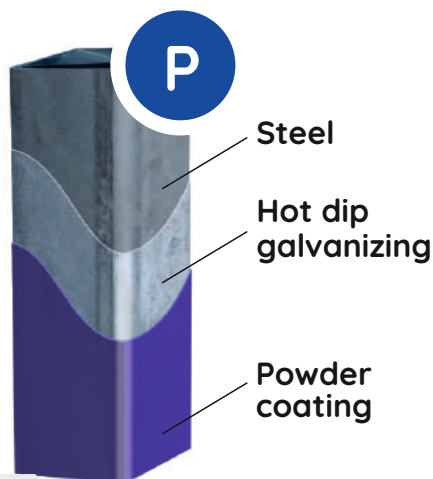



# THEMED PLAYGROUNDS



S	P, I, W, WI
+	6,44x2,60x3,50 m
▨	37,84 m <sup>2</sup>
⊞	9,53 x 5,60 m
HIC	1,20 m
NORM	EN 1176-1:2017

Treehouse with a pier

**P1502**



S	P, I, W, WI
+	3,98x3,30x3,50 m
▨	33,33 m <sup>2</sup>
⊞	7,48 x 6,30 m
HIC	1,20 m
NORM	EN 1176-1:2017

Treehouse

**P1501**





- S P, I, W, WI
- + 2,30 x 2,05 x 3,30 m
- ▨ 20,94 m<sup>2</sup>
- ⊞ 5,30 x 5,05 m
- HIC 0,90 m
- NORM EN 1176-1:2017

*Where does Mrs. Ladybird live?*



Small Treehouse

**P1503**

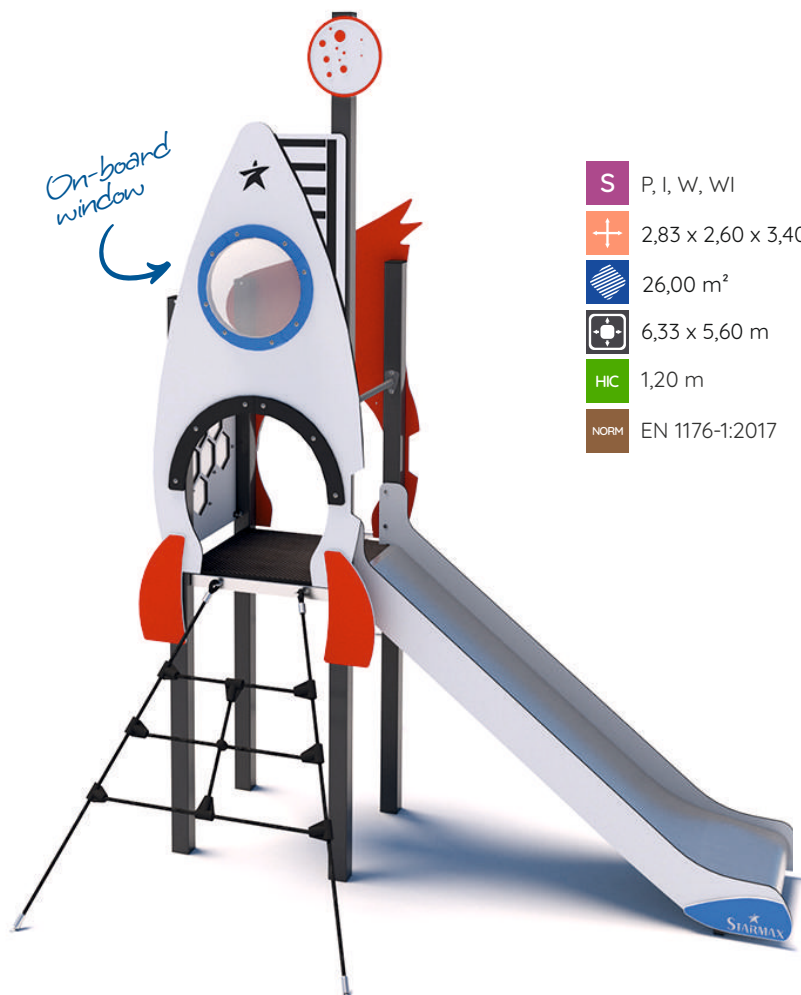

*On-board window*

- S P, I, W, WI
- + 2,83 x 2,60 x 3,40 m
- ▨ 26,00 m<sup>2</sup>
- ⊞ 6,33 x 5,60 m
- HIC 1,20 m
- NORM EN 1176-1:2017

*Swoosh... Follow the comet!*



*Stainless stairs*

Rocket and comet

**P1506**

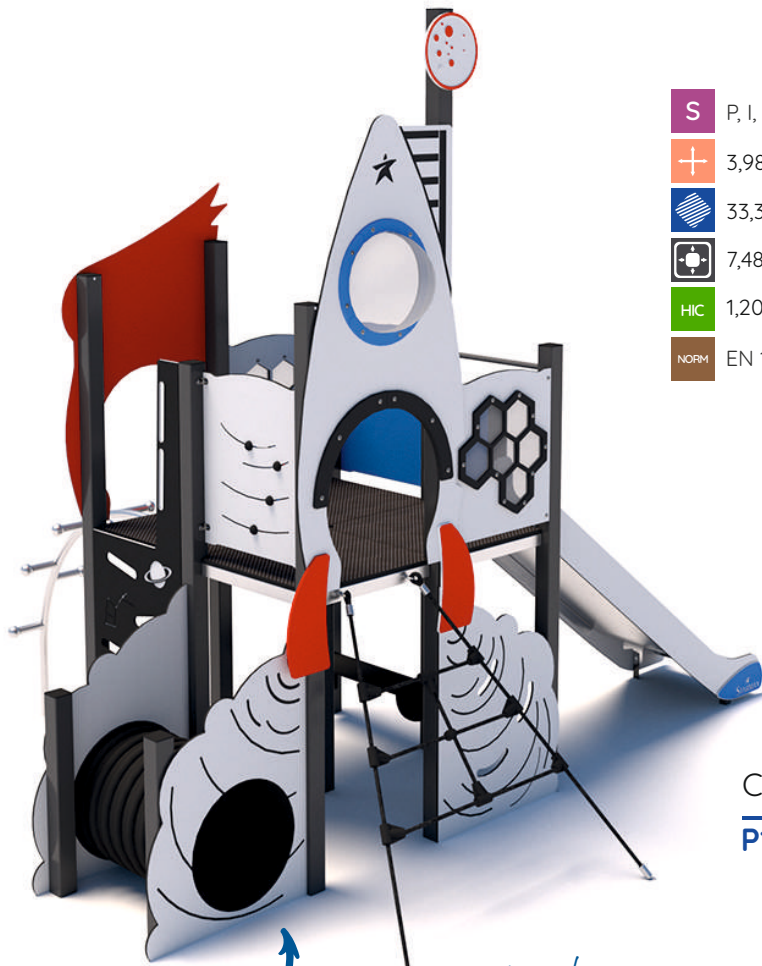

- S P, I, W, WI
- + 3,98 x 3,30 x 3,40 m
- ▨ 33,33 m<sup>2</sup>
- ⊕ 7,48 x 6,30 m
- HIC 1,20 m
- NORM EN 1176-1:2017



Cosmos  
**P1504**

*The way to board lies through the tunnel :)*



- S P, I, W, WI
- + 6,44 x 2,60 x 3,40 m
- ▨ 37,84 m<sup>2</sup>
- ⊕ 9,53 x 5,60 m
- HIC 1,20 m
- NORM EN 1176-1:2017

*How about this set with stainless or wooden poles?*

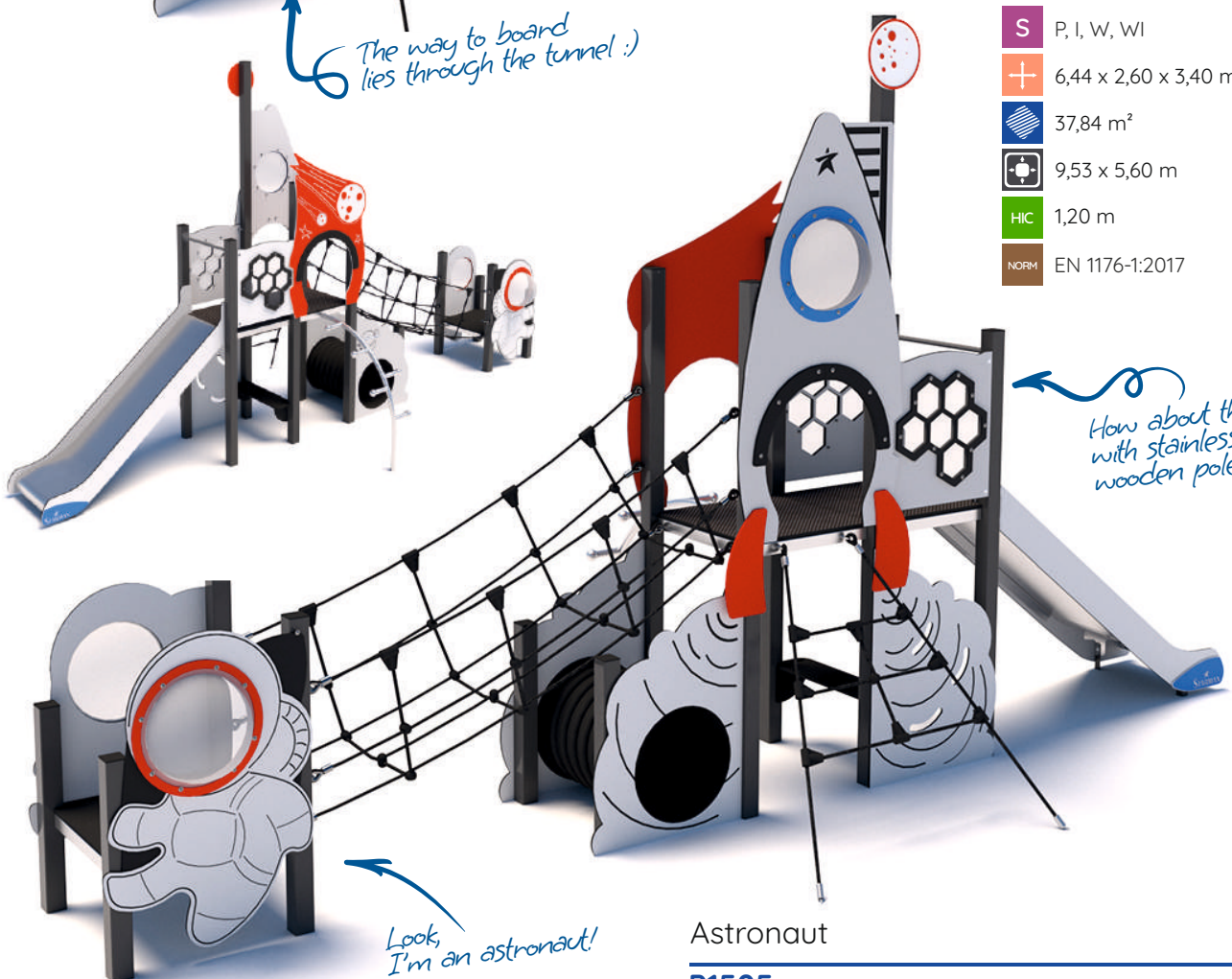

*Look, I'm an astronaut!*

Astronaut  
**P1505**





- S P, I
- + 3,42 x 1,32 x 2,00 m
- ▨ 22,95 m<sup>2</sup>
- ⊕ 6,42 x 4,32 m
- HIC 0,60 m
- NORM EN 1176-1:2017

*I like wide slides!*



Locomotive with a slide

**P3504**

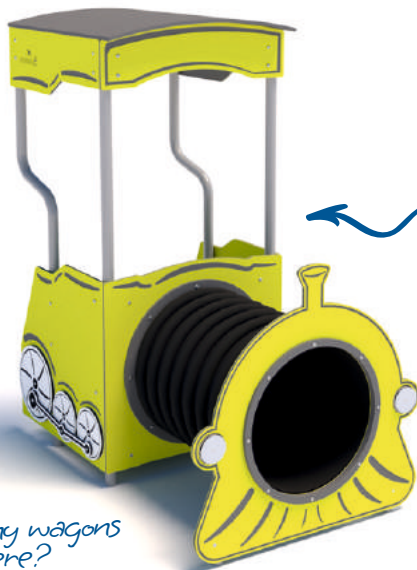

*Lime puffing billy*

*How many wagons will be here?*

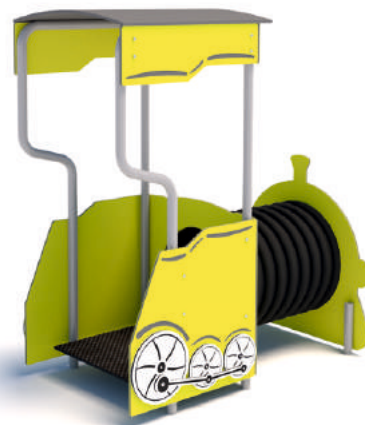

- S P, I
- + 0,92 x 1,47 x 1,67 m
- ▨ 15,57 m<sup>2</sup>
- ⊕ 3,92 x 3,47 m
- HIC 0,17 m
- NORM EN 1176-1:2017

Locomotive

**P3501**

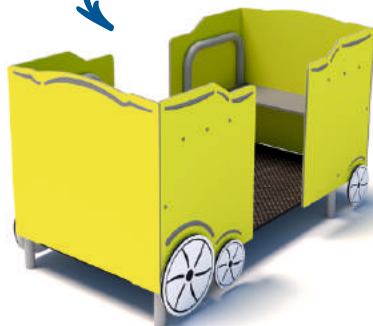

- S P, I
- + 1,53 x 0,80 x 0,88 m
- ▨ 15,28 m<sup>2</sup>
- ⊕ 4,53 x 3,80 m
- HIC 0,15 m
- NORM EN 1176-1:2017

Railway carriage

**P3502**

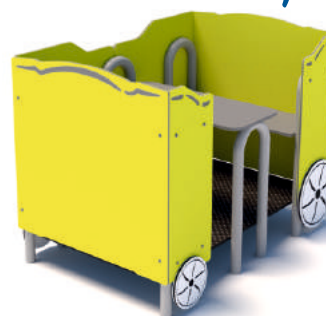

*Look, table is in there!*

- S P, I
- + 1,18 x 0,80 x 0,88 m
- ▨ 13,90 m<sup>2</sup>
- ⊕ 4,18 x 3,80 m
- HIC 0,15 m
- NORM EN 1176-1:2017

Railway carriage with table

**P3503**

# THEMED PLAYGROUNDS

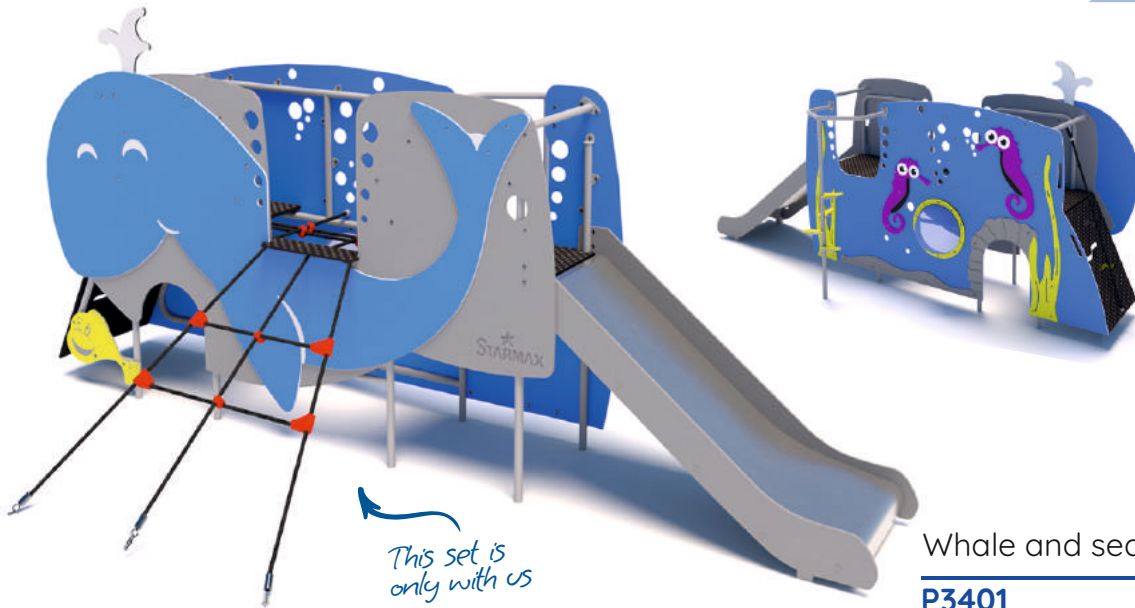

S	P, I
+	4,09 x 2,43 x 1,90 m
▨	28,64 m <sup>2</sup>
⊕	7,09 x 5,43 m
HIC	0,90 m
NORM	EN 1176-1:2017

Whale and seahorses set

**P3401**

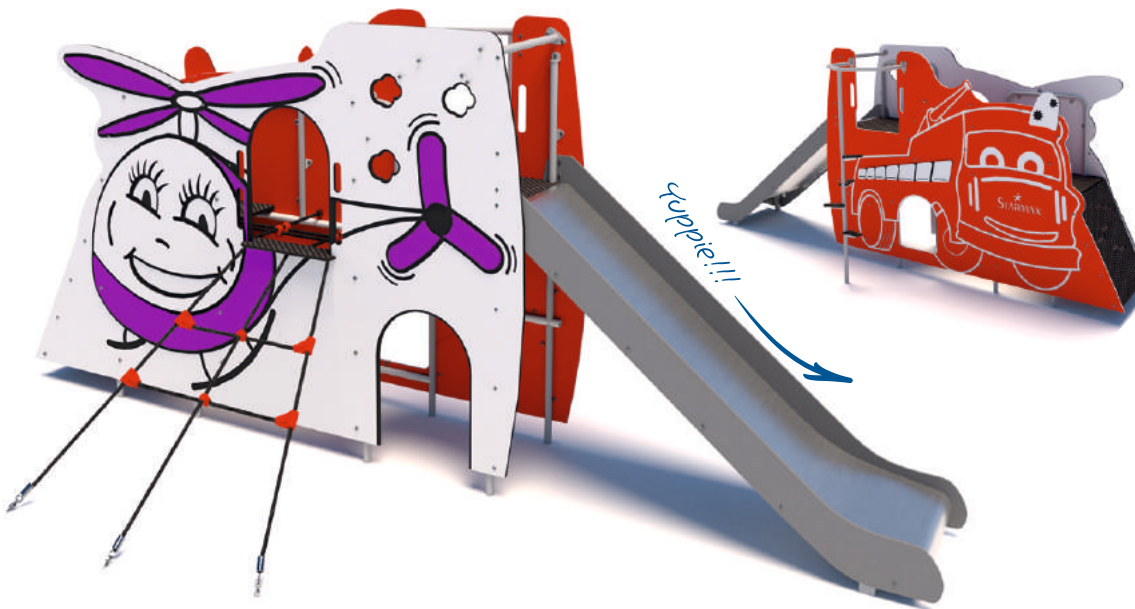

S	P, I
+	4,49 x 2,43 x 1,90 m
▨	29,85 m <sup>2</sup>
⊕	7,49 x 5,43 m
HIC	1,20 m
NORM	EN 1176-1:2017

Helicopter and Fire truck

**P3402**



S	P, I
+	4,97 x 2,98 x 2,14 m
▨	36,60 m <sup>2</sup>
⊕	7,97 x 5,98 m
HIC	0,90 m
NORM	EN 1176-1:2017

Fire engine

**P3403**





S	P, I, W, WI
+	1,06 x 1,62 x 2,19 m
▨	15,36 m <sup>2</sup>
⊕	4,02 x 4,52 m
HIC	0,15 m
NORM	EN 1176-1:2017



S	P, I, W, WI
+	2,38 x 2,38 x 2,19 m
▨	22,8 m <sup>2</sup>
⊕	5,20 x 5,27 m
HIC	0,15 m
NORM	EN 1176-1:2017



*Choose your monster :)*

Playground set

**P1101**

Playground set

**P1102**



*Each of the sets can be chosen in a monster or forest theme*



*I like wide slides!*



S	P, I, W, WI
+	4,00 x 1,81 x 2,59 m
▨	28,50 m <sup>2</sup>
⊕	7,00 x 4,81 m
HIC	0,55 m
NORM	EN 1176-1:2017



S	P, I, W, WI
+	4,53 x 2,70 x 2,59 m
▨	33,16 m <sup>2</sup>
⊕	7,53 x 5,70 m
HIC	0,55 m
NORM	EN 1176-1:2017

Playground set

**P1103**

Playground set

**P1104**



S	P, I, W, WI
+	1,07 x 2,00 x 2,40 m
▨	16,81 m <sup>2</sup>
⊞	4,07 x 5,00 m
HIC	0,55 m
NORM	EN 1176-1:2017



S	P, I, W, WI
+	3,55 x 2,47 x 2,59 m
▨	27,42 m <sup>2</sup>
⊞	6,55 x 5,47 m
HIC	0,90 m
NORM	EN 1176-1:2017



*What will be the standard of workmanship, stainless steel, wood or painted steel?*

Playground set

**P1106**

Playground set

**P1105**

*The sandpit was necessary :)*



S	P, I, W, WI
+	1,78 x 2,83 x 2,59 m
▨	25,96 m <sup>2</sup>
⊞	4,78 x 5,83 m
HIC	0,55 m
NORM	EN 1176-1:2017

Playground set

**P1108**



S	P, I, W, WI
+	4,63 x 2,03 x 2,00 m
▨	29,57 m <sup>2</sup>
⊞	7,63 x 5,03 m
HIC	1,20 m
NORM	EN 1176-1:2017



S	P, I, W, WI
+	1,52 x 2,30 x 2,43 m
▨	19,97 m <sup>2</sup>
⊞	4,52 x 5,30 m
HIC	0,60 m
NORM	EN 1176-1:2017

Playground set

**P1120**



Playground set

**P1121**





- S** P, I, W, WI
- +** 7,36 x 4,60 x 3,76 m
- ▨** 58,60 m<sup>2</sup>
- ⊞** 10,36 x 7,67 m
- HIC** 1,78 m
- NORM** EN 1176-1:2017



*We have fun with the whole class!*

Playground set

**P1119**



- S** P, I, W, WI
- +** 3,46 x 1,81 x 2,70 m
- ▨** 23,92 m<sup>2</sup>
- ⊞** 6,46 x 4,81 m
- HIC** 0,90 m
- NORM** EN 1176-1:2017

Playground set

**P1140**



- S** P, I, W, WI
- +** 2,83 x 2,67 x 3,05 m
- ▨** 23,43 m<sup>2</sup>
- ⊞** 5,83 x 5,72 m
- HIC** 1,58 m
- NORM** EN 1176-1:2017

Playground set

**P1129**



*Such wide slides 62 cm only with us*



- S** P, I, W, WI
- +** 6,00 x 3,97 x 3,50 m
- ▨** 48,66 m<sup>2</sup>
- ⊞** 9,00 x 7,47 m
- HIC** 1,50 m
- NORM** EN 1176-1:2017

Playground set

**P1123**

# THEMED PLAYGROUNDS



- S S, P, I
- + 7,57 x 4,23 x 2,74 m
- ▨ 57,98 m<sup>2</sup>
- ⊕ 10,57 x 7,23 m
- HIC 1,20 m
- NORM EN 1176:2016

Playground set

**P1124**



- S P, I, W, WI
- + 9,54 x 6,04 x 3,05 m
- ▨ 79,88 m<sup>2</sup>
- ⊕ 12,54 x 9,54 m
- HIC 1,50 m
- NORM EN 1176-1:2017

*I like wide and big slides!*

Playground set

**P1130**





- S P, I, W, WI
- + 5,02 x 5,09 x 2,99 m
- ▨ 44,61 m<sup>2</sup>
- ⊕ 8,02 x 8,09 m
- HIC 0,95 m
- NORM EN 1176-1:2017

Playground set

**P1110**

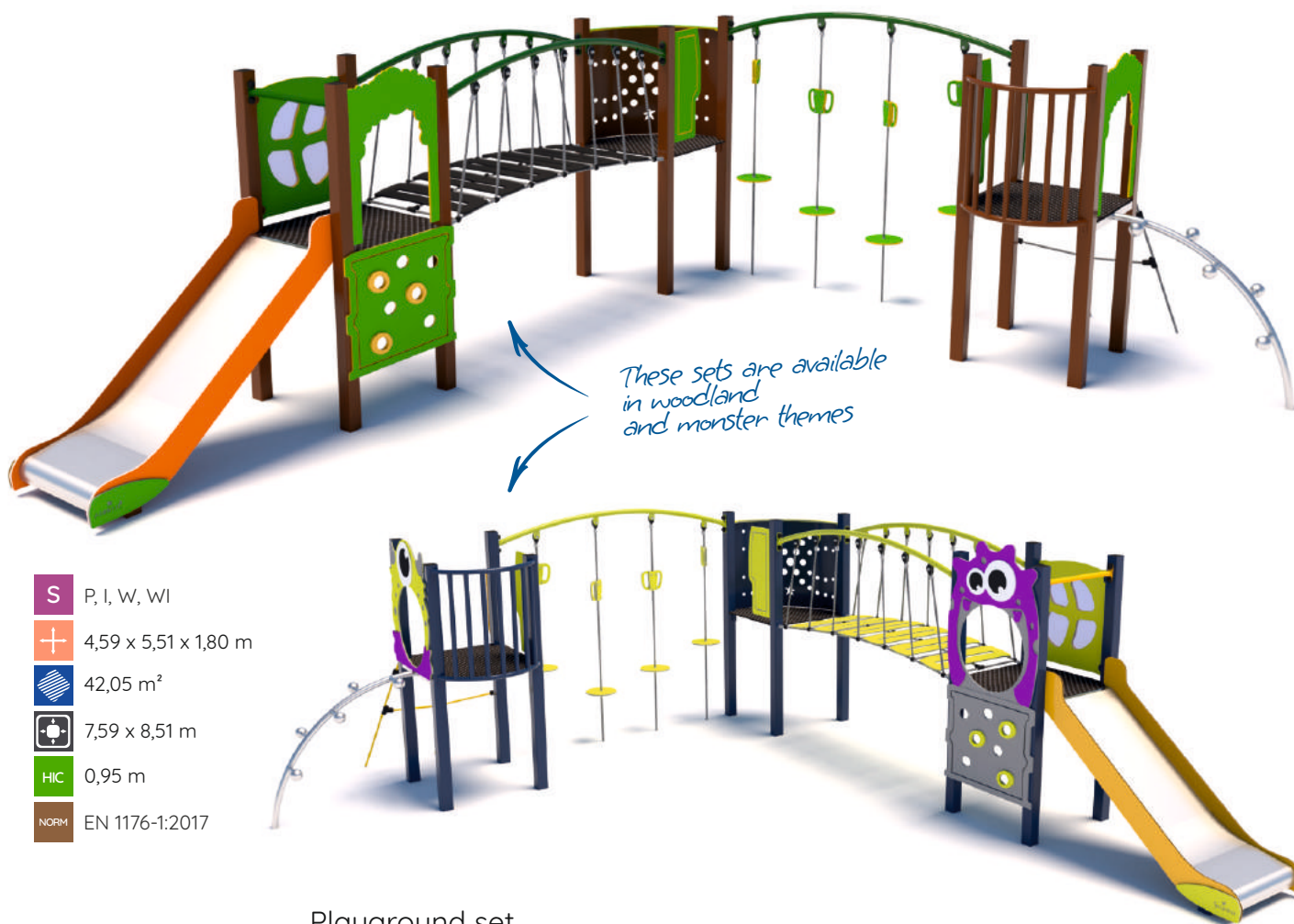

*These sets are available  
in woodland  
and monster themes*

- S P, I, W, WI
- + 4,59 x 5,51 x 1,80 m
- ▨ 42,05 m<sup>2</sup>
- ⊕ 7,59 x 8,51 m
- HIC 0,95 m
- NORM EN 1176-1:2017

Playground set

**P1112**

# THEMED PLAYGROUNDS



- S P, I, W, WI
- + 5,04 x 4,40 x 2,99 m
- ▨ 48,50 m<sup>2</sup>
- ⊞ 8,04 x 7,40 m
- HIC 0,95 m
- NORM EN 1176-1:2017

Playground set

**P1111**



- S P, I, W, WI
- + 4,72 x 2,88 x 3,39 m
- ▨ 34,00 m<sup>2</sup>
- ⊞ 7,72 x 6,28 m
- HIC 1,35 m
- NORM EN 1176-1:2017

Playground set

**P1113**

- S P, I, W, WI
- + 4,22 x 4,92 x 2,93 m
- ▨ 45,38 m<sup>2</sup>
- ⊞ 7,22 x 8,57 m
- HIC 1,20 m
- NORM EN 1176-1:2017



Playground set

**P1114**



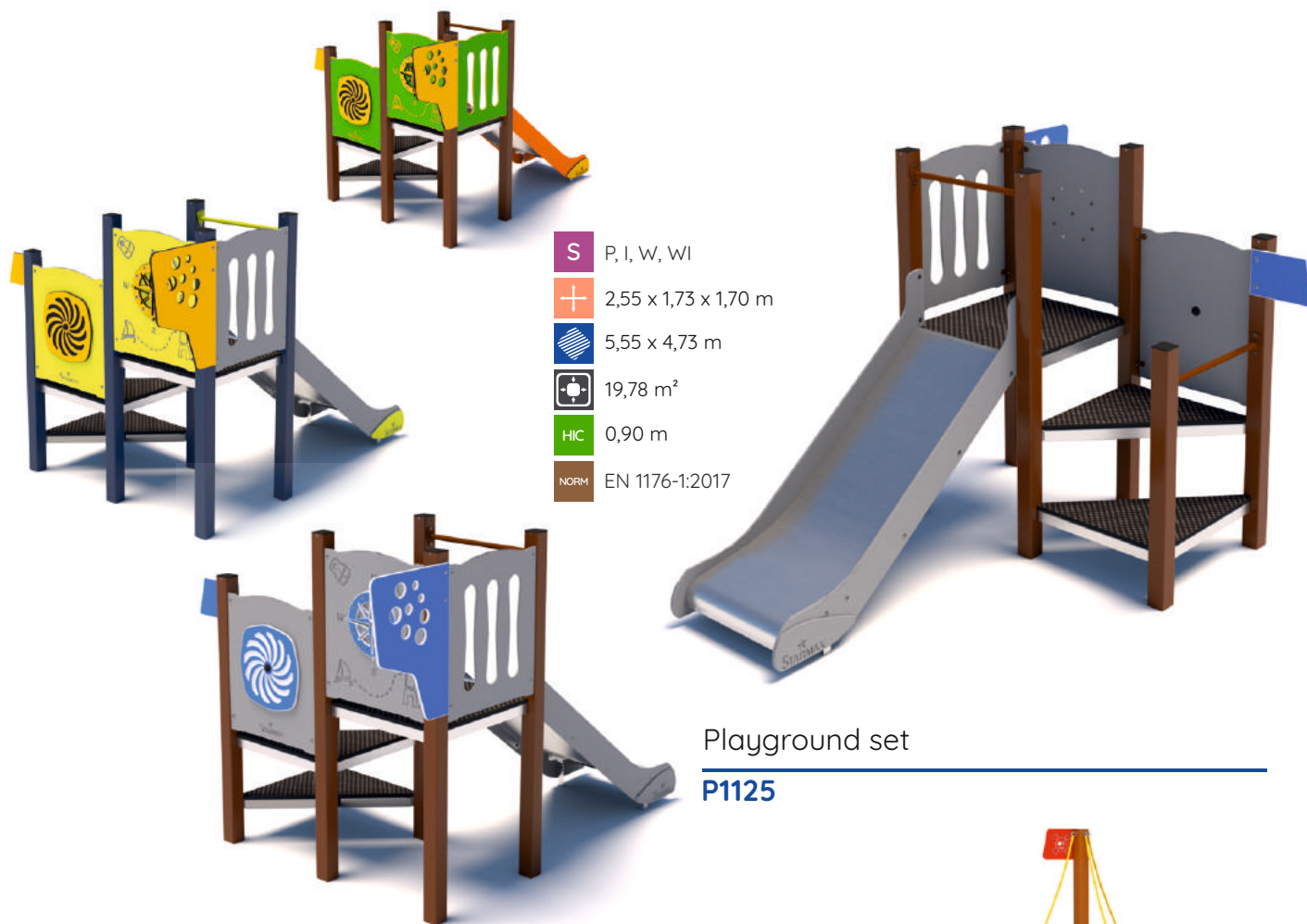

- S P, I, W, WI
- + 2,55 x 1,73 x 1,70 m
- ▨ 5,55 x 4,73 m
- ⊕ 19,78 m<sup>2</sup>
- HIC 0,90 m
- NORM EN 1176-1:2017

Playground set  
**P1125**



- S P, I, W, WI
- + 3,15 x 1,87 x 2,81 m
- ▨ 25,62 m<sup>2</sup>
- ⊕ 6,21 x 5,08 m
- HIC 0,90 m
- NORM EN 1176-1:2017

Playground set  
**P1109**



- S P, I, W, WI
- + 5,96 x 5,91 x 2,84 m
- ▨ 56,43 m<sup>2</sup>
- ⊕ 8,96 x 8,91 m
- HIC 2,84 m
- NORM EN 1176-1:2017



Inclusive playground set

**P1135**

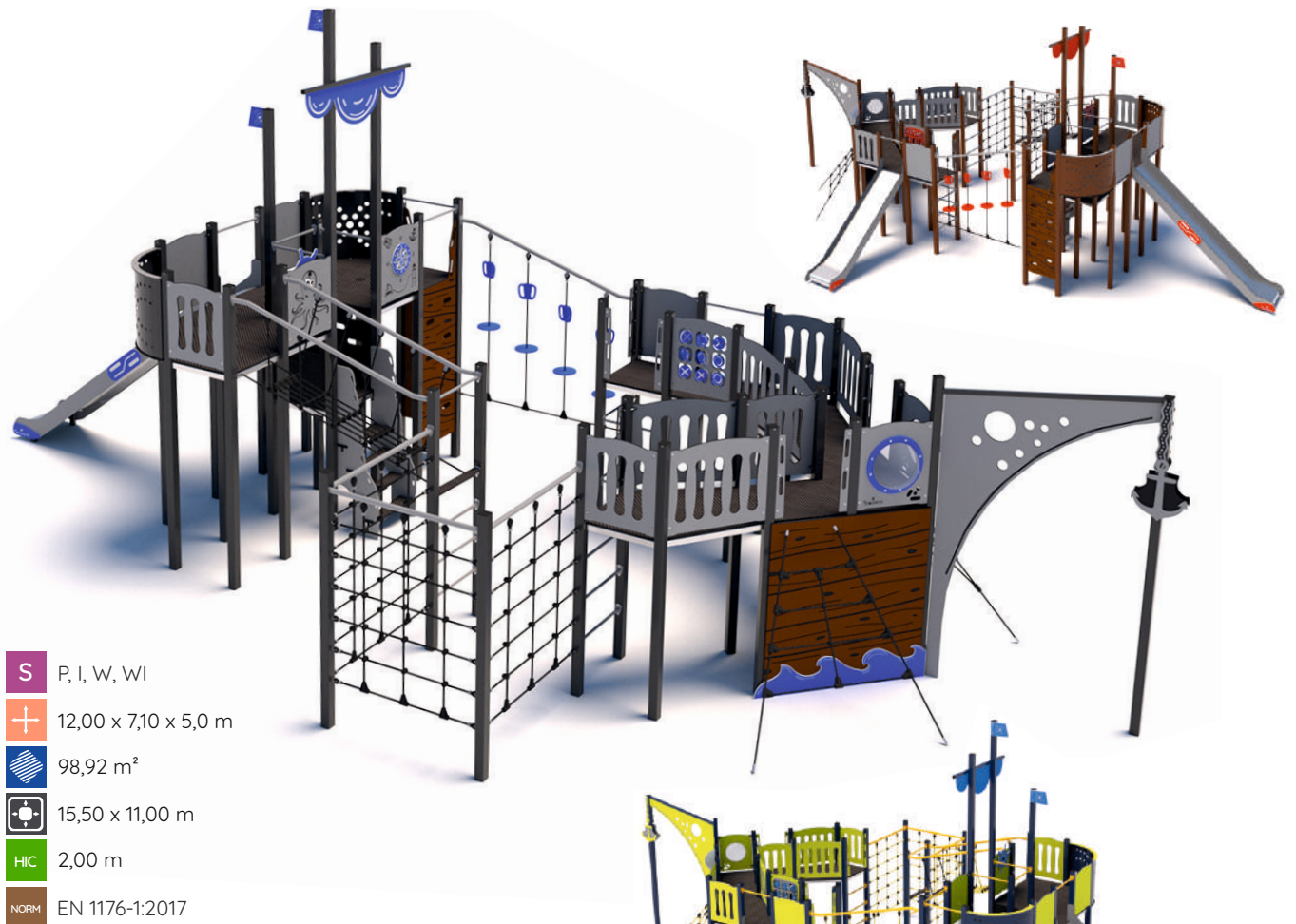

- S P, I, W, WI
- + 12,00 x 7,10 x 5,0 m
- ▨ 98,92 m<sup>2</sup>
- ⊕ 15,50 x 11,00 m
- HIC 2,00 m
- NORM EN 1176-1:2017

Playground set

**P1127**



## SWINGS



P2001



P2002



P2005



P2006



P2008



P2007



P2003



P2004



P2301



P



K



B



Choose a seat for your Flat, Bucket or Crow's Nest swing.



Choose the standard of execution: a swing with steel, wooden or stainless steel legs.

CODE	S	+	▨	HIC	⊕	NORM
P2001	P, I	2,90 x 2,00 x 2,34 m	12,06 m <sup>2</sup>	1,26 m	6,70 x 1,80 m	EN 1176-1
P2002	P, I	3,20 x 2,00 x 2,34 m	19,83 m <sup>2</sup>	1,26 m	6,70 x 2,96 m	EN 1176-1
P2003	P, I	5,68 x 2,00 x 2,34 m	33,23 m <sup>2</sup>	1,26 m	6,70 x 4,96 m	EN 1176-1
P2004	P, I	6,31 x 2,00 x 2,34 m	42,24 m <sup>2</sup>	1,25 m	6,70 x 6,83 m	EN 1176-1
P2005	P, I	6,39 x 2,00 x 2,34 m	37,32 m <sup>2</sup>	1,25 m	6,70 x 5,57 m	EN 1176-1
P2006	P, I	2,00 x 2,32 x 2,34 m	21,80 m <sup>2</sup>	1,25 m	6,70 x 3,25 m	EN 1176-1
P2007	P, I	5,91 x 2,00 x 2,34 m	32,83 m <sup>2</sup>	1,25 m	4,90 x 6,70 m	EN 1176-1
P2008	P, I	5,30 x 2,00 x 2,34 m	32,16 m <sup>2</sup>	1,25 m	6,70 x 4,80 m	EN 1176-1
P2301	P, I	3,02 x 0,28 x 0,93 m	10,60 m <sup>2</sup>	0,85 m	5,02 x 2,28 m	EN 1176-1

## ACTIVE PLAY SETS

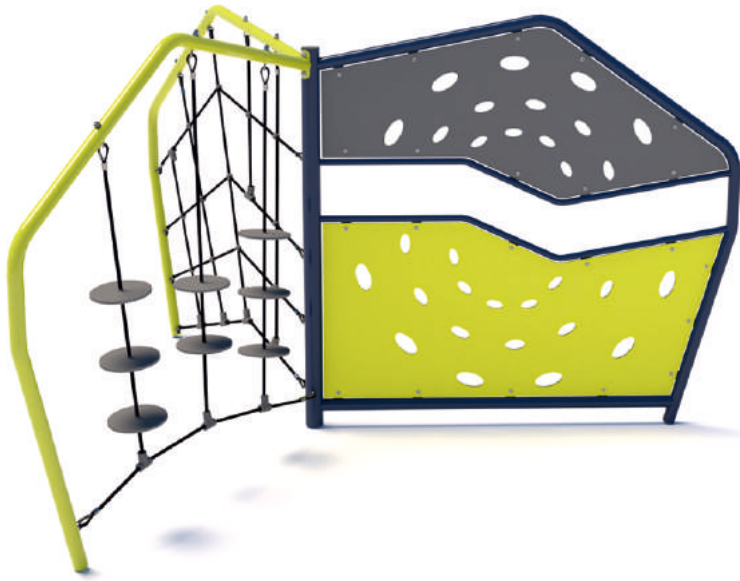

S	P, I
+	3,18 x 3,82 x 2,03 m
▨	34,15 m <sup>2</sup>
⊕	6,85 x 7,32 m
HIC	1,8 m
NORM	EN 1176-1:2017



Active play set "Triple wall"

**P5001**



S	P, I
+	2,65 x 2,58 x 2,1 m
▨	36,67 m <sup>2</sup>
⊕	6,33 x 6,26 m
HIC	2,0 m
NORM	EN 1176-1:2017



Active play set "BOX"

**P5003**

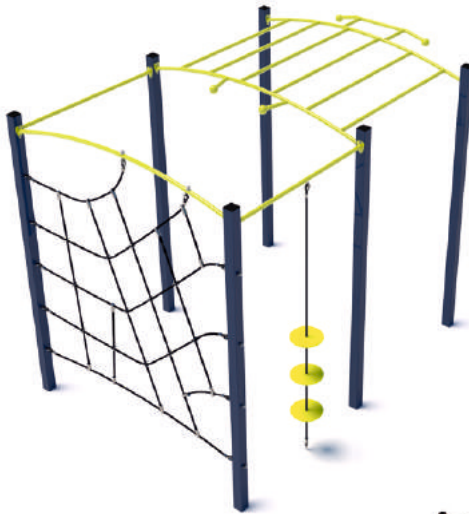

S	P, I
+	3,19 x 2,31 x 2,58 m
▨	37,30 m <sup>2</sup>
⊕	6,79 x 5,91 m
HIC	2,00 m
NORM	EN 1176-1:2017



Active play set "Bars and net wall"

**P5007**



S	P, I
+	3,08 x 0,89 x 2,50 m
▨	25,25 m <sup>2</sup>
⊕	6,55 x 4,74 m
HIC	2,20 m
NORM	EN 1176-1:2017

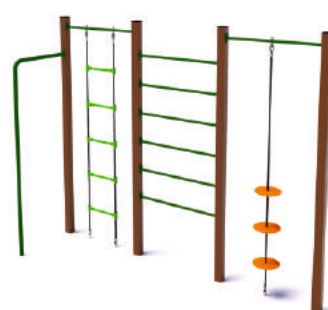

Active play set "Bars and ladder"

**P5006**



## PLAY SPRINGERS



Horse

P3002



Bendy

P3003



Fancy

P3004



Shanky

P3005



Dino

P3010



Camelove

P3014



Scooter

P3008



Lion

P3007



Elephant

P3009

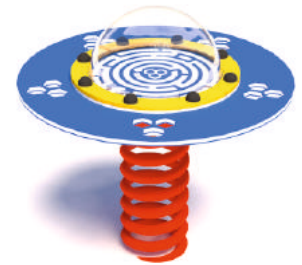

Maze

P3801



Panda

P3019

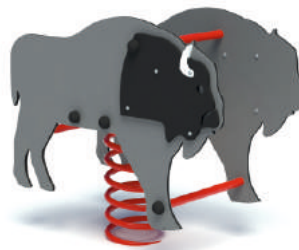

Wisent

P3011



Koala

P3020



Monstertruck

P3015



Carriage

P3012



Fire truck

P3013

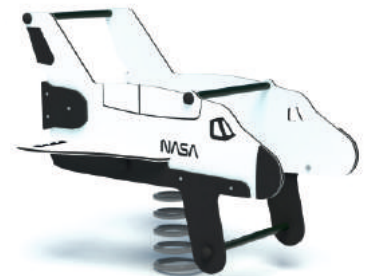

Shuttle

P3017

## SLIDERS



S	P, I
+	1,90 x 0,64 x 1,66 m
▨	14,2 m <sup>2</sup>
⊞	4,85 x 3,64 m
HIC	0,9 m
NORM	EN 1176-1:2017



Playground slider

**P3301**



S	P, I
+	2,25 x 0,64 x 1,98 m
▨	15,09 m <sup>2</sup>
⊞	5,20 x 3,64 m
HIC	1,2 m
NORM	EN 1176-1:2017

Playground slider

**P3302**



S	P, I
+	2,95 x 0,80 x 2,40 m
▨	19,20 m <sup>2</sup>
⊞	6,40 x 3,80 m
HIC	1,5 m
NORM	EN 1176-1:2017

Playground slider

**P3304**



S	P, I
+	2,25 x 0,64 x 1,98 m
▨	15,09 m <sup>2</sup>
⊞	5,20 x 3,64 m
HIC	1,2 m
NORM	EN 1176-1:2017

Playground slider

**P3303**

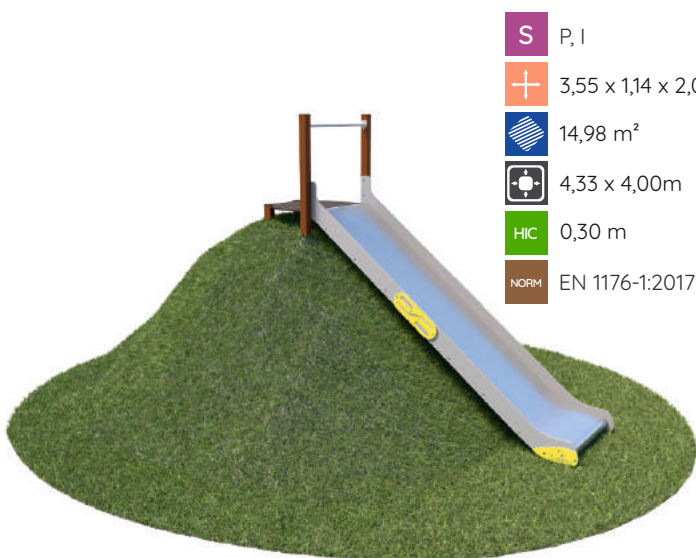

S	P, I
+	3,55 x 1,14 x 2,0 m
▨	14,98 m <sup>2</sup>
⊞	4,33 x 4,00 m
HIC	0,30 m
NORM	EN 1176-1:2017

Playground slider

**P3306**



S	P, I
+	2,53 x 1,14 x 1,20 m
▨	10,90 m <sup>2</sup>
⊞	4,31 x 4,00 m
HIC	0,30 m
NORM	EN 1176-1:2017

Playground slider

**P3305**



# EDUCATIONAL PLAY PANELS



Dice

P3804



Racing

P3806



Alphabet

P3810



Mathematics

P3812



Beekeeper

P3809



Clock

P3803



Compass

P3807



Steering wheel

P3811



Digits

P3808



Tic Tac Toe

P3802



Throw the ball

P3805



P3806

P3803

P3804



P3808



P3809



P3802

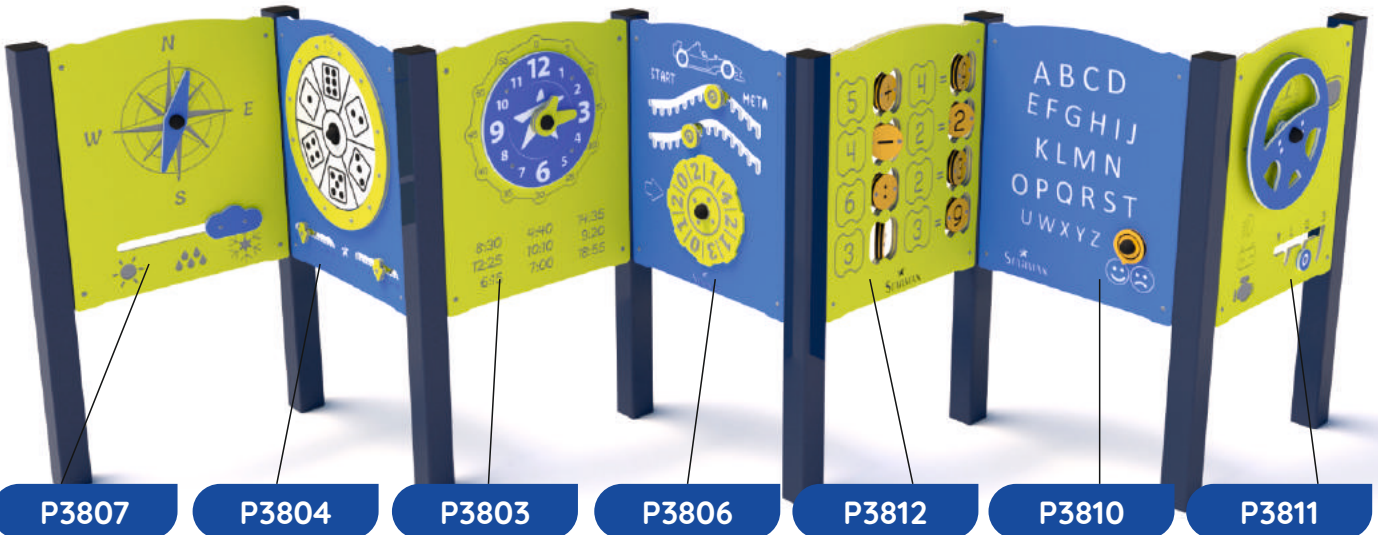

P3807

P3804

P3803

P3806

P3812

P3810

P3811

## RECREATION ELEMENTS AND SANDPITS

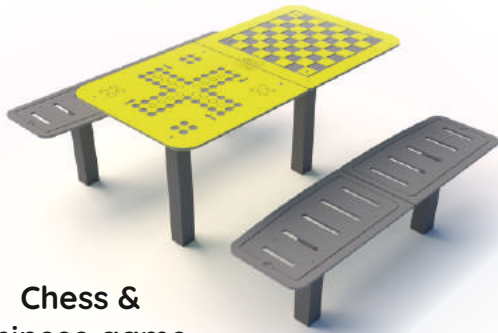

Chess &  
Chinese game

P8402



Single hammock

P8601

Double hammock

P8602



Balance beam

P3701



Tunnel

P2401

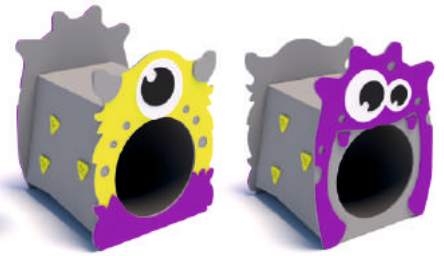

Monster tunnel

P2403

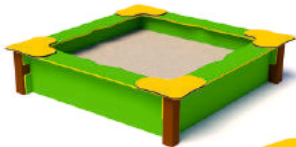

Sandpit

P3201

1,60 x 1,60 m

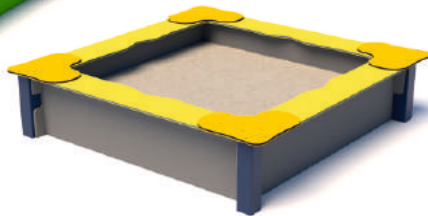

Sandpit

P3202

2,43 x 2,43 m

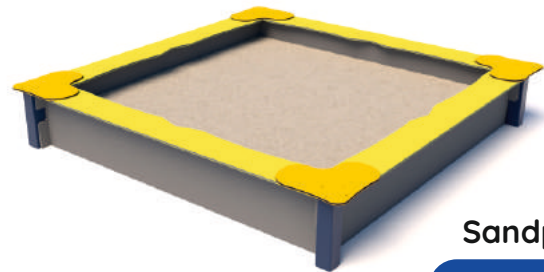

Sandpit

P3203

3,00 x 3,00 m

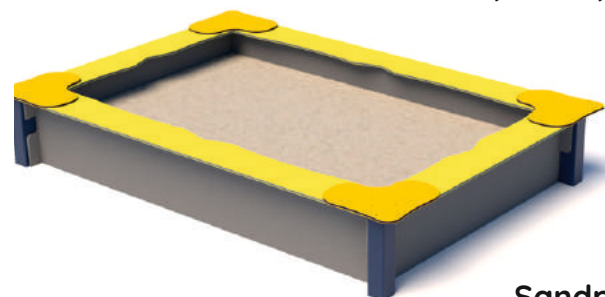

Sandpit

P3204

2,30 x 1,60 m

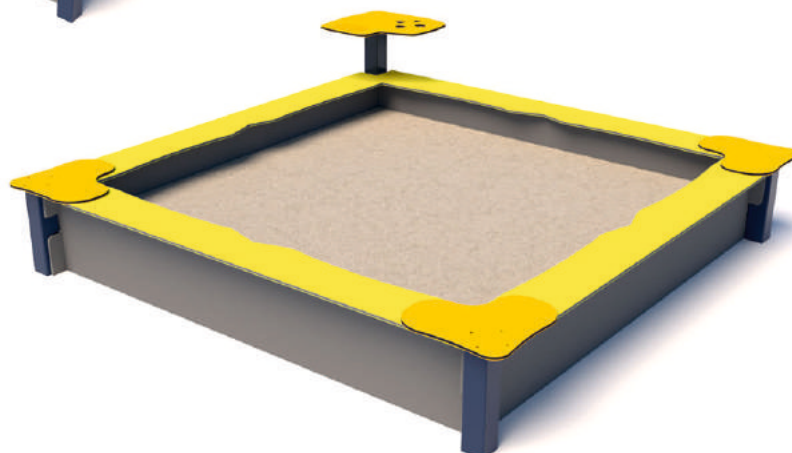

Sandpit

P3205

2,43 x 2,43 m





## Outdoor mini-gyms - OFK series

**Seeing children's interest in outdoor gyms, we have created a set of outdoor exercise equipment tailored to the height and skills of our children.**

The OFK series of mini gyms accustoms children to physical activity through play and popularizes a sporty lifestyle. The OFK series is a perfect supplement to a traditional outdoor gym for adults or a recreation area at school. OFK mini gyms allow small users to practice sports and have fun at the same time.

Thanks to the ease and intuitiveness of the exercises, children quickly achieve efficiency in performing tasks. This builds positive self-esteem and the spirit of an athlete. If the parent appreciates the child's efforts, he will come home with a little happy superhero!

OFK mini gym devices have been designed based on the EN 16630:2015-06 and EN 1176-1/2017-12 standards. Thanks to this, we consider our products safe for every user.

## Outdoor Mini-gyms - OFK series

*Cheerful lime and navy blue colors*



S	PM, MM
+	1,16 x 0,48 x 1,15 m
▨	12,56 m <sup>2</sup>
⊕	4,16 x 3,48 m
HIC	0,39 m
NORM	EN 16630:2015-06

Air Walker

OFK-01



S	PM, MM
+	1,78 x 0,53 x 1,30 m
▨	15,04 m <sup>2</sup>
⊕	4,78 x 3,53 m
HIC	0,64 m
NORM	EN 16630:2015-06

Bicycle + Stepper

OFK-09+10



*We like to exercise in four - our whole pack!*

S	PM, MM
+	2,38 x 1,13 x 1,30 m
▨	20,43 m <sup>2</sup>
⊕	5,38 x 4,13 m
HIC	0,64 m
NORM	EN 16630:2015-06

Combo Superhero

OFK-12



We practice together with the kids



Fun through exercise



Get your kids to spend time outside



Popularize sport for kids



S	PM, MM
+	1,15 x 1,13 x 1,22 m
▨	15,19 m <sup>2</sup>
⊕	4,15 x 4,13 m
HIC	0,39 m
NORM	EN 16630:2015-06

Ski Trainer + Hips

OFK-11+07



S	PM, MM
+	1,15 x 0,71 x 1,28 m
▨	13,49 m <sup>2</sup>
⊕	4,15 x 3,71 m
HIC	0,00 m
NORM	EN 16630:2015-06

Tai Chi small wheels

OFK-03





PONAD  
**10 000**  
PROJEKTÓW



100%  
POLSKI  
PRODUKT

# THE PERFECT SUPPLEMENT TO THE TRADITIONAL OUTDOOR GYM



## Outdoor Mini-gyms - OFK series



S	PM, MM
+	0,62 x 0,94 x 0,97 m
▨	12,37 m <sup>2</sup>
⊕	3,62 x 3,94 m
HIC	0,53 m
NORM	EN 16630:2015-06

Rider

**OFK-02**



S	PM, MM
+	1,15 x 1,48 x 1,22 m
▨	16,62 m <sup>2</sup>
⊕	4,15 x 4,48 m
HIC	0,73 m
NORM	EN 16630:2015-06

Twisters

**OFK-04+05**

*For me and my best friend*



S	PM, MM
+	1,96 x 0,48 x 1,15 m
▨	15,34 m <sup>2</sup>
⊕	4,96 x 3,48 m
HIC	0,39 m
NORM	EN 16630:2015-06

Double Air Walker

**OFK-01\_1**



Supplement your outdoor gym with devices adapted for kids



OFK series manufactured regarding EN 16630:2015-06 safety norm



Get the kids used to physical activity on the fresh air



Ask about OFK devices adapted for EN 1176-1/2017-12 norm

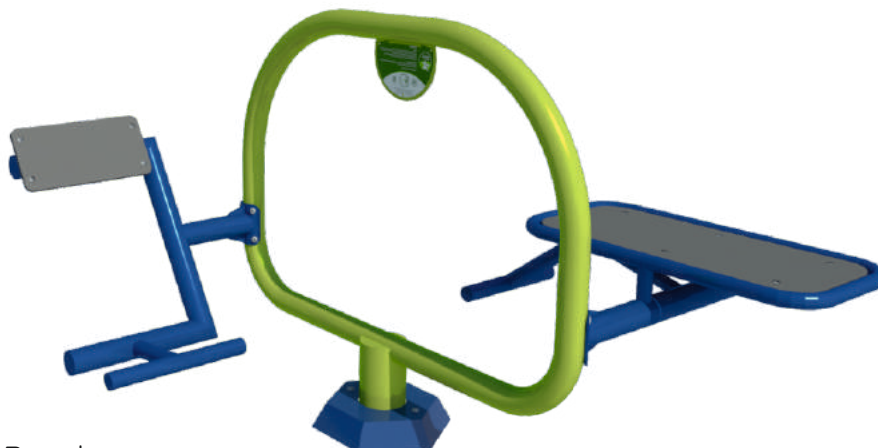

S	PM, MM
+	3,61 x 1,22 x 0,99 m
▨	17,58 m <sup>2</sup>
⊕	4,61 x 4,22 m
HIC	0,51 m
NORM	EN 16630:2015-06

Back Trainer + Bench

**OFK-06+08**





S	PM, MM
+	0,39 x 1,32 x 1,18 m
▨	12,74 m <sup>2</sup>
⊞	3,39 x 4,32 m
HIC	0,36 m
NORM	EN 1176-1: 2017-12

Air Walker - for playground

OFK-21



Get playing and learning exercise



S	PM, MM
+	1,73 x 0,53 x 1,14 m
▨	14,78 m <sup>2</sup>
⊞	4,73 x 3,53 m
HIC	0,61 m
NORM	EN 1176-1: 2017-12

Bicycle + Hand cycle - for playground

OFK-29



OFK is adapted for playgrounds



S	PM, MM
+	2,33 x 1,13 x 1,15 m
▨	20,00 m <sup>2</sup>
⊞	5,33 x 4,13 m
HIC	0,61 m
NORM	EN 1176-1: 2017-12



Combo Superhero - for playground

OFK-32



Exercise through play with OFK



Health is the best argument



S	PM, MM
+	1,28 x 1,16 x 0,99 m
▨	15,87 m <sup>2</sup>
⊞	4,28 x 4,16 m
HIC	0,53 m
NORM	EN 1176-1: 2017-12

Twisters - for playground

OFK-25



S	PM, MM
+	0,70 x 1,16 x 1,31 m
▨	13,45 m <sup>2</sup>
⊞	3,70 x 4,16 m
HIC	0,00 m
NORM	EN 1176-1: 2017-12

Tai Chi wheels - for playground

OFK-23

## Playground Mini-gyms - OFK series



S	PM, MM
+	1,16 x 0,59 x 1,00 m
▨	13,00 m <sup>2</sup>
⊞	4,16 x 3,59 m
HIC	0,37 m
NORM	EN 1176-1: 2017-12

Single legs press - for playground

**OFK-27**



Playing and resting healthy



S	PM, MM
+	1,16 x 1,05 x 1,00 m
▨	15,04 m <sup>2</sup>
⊞	4,16 x 4,05 m
HIC	0,37 m
NORM	EN 1176-1: 2017-12

Double legs press - for playground

**OFK-27\_1**



Made based on the EN 1176-1: 2017-12 norm for playgrounds

S	PM, MM
+	2,53 x 0,45 x 1,18 m
▨	17,14 m <sup>2</sup>
⊞	5,53 x 3,45 m
HIC	0,36 m
NORM	EN 1176-1: 2017-12



*Best friends forever!*

Double Air walker - for playground

**OFK-21\_1**



OFK - Training becomes fun!



Encourage kids to play sports



S	PM, MM
+	1,63 x 1,35 x 0,99 m
▨	18,22 m <sup>2</sup>
⊞	4,63 x 4,35 m
HIC	0,50 m
NORM	EN 1176-1: 2017-12

Back trainer + Bench - for playground

**OFK-26+28**



S	PM, MM
+	1,16 x 1,13 x 1,15 m
▨	15,27 m <sup>2</sup>
⊞	4,16 x 4,13 m
HIC	0,37 m
NORM	EN 1176-1: 2017-12

Legs press + Ski trainer - for playground

**OFK-27+31**





## Playground trampolines outstanding fun and effective training

STARMAX playground trampolines are designed for outdoor use in public places. Starmax trampolines are perfect for schools, kindergartens and sports facilities. Our trampolines are not only fantastic fun that brings great joy and a positive impact on children's health, but also progressive training for adults.

Exercises based on dynamic jumps engage almost all the muscles of our body, which transform into effective burning of unnecessary calories in the body.

During one session we can burn up to 1200 kcal! Besides, outdoor activity helps to get rid of stress and improve mood.

Our playground trampolines are designed to combine fun and effective training.

All elements of our trampolines are resistant to various weather conditions and can be used during the year.

The jumping mat with increased vandal resistance is made of blocks suspended on stainless steel ropes and springs.

The main structure is galvanized for added corrosion resistance.

STARMAX trampolines are fully certified in accordance with the EN-1176-2017 standard. Because of comply the conditions of this standard, we are sure that our playground trampolines are safe for each user.







SPECIAL MARKING:



- Jumping area

## Trampoline "Mini"

### T-80S

 0,84 x 0,84 m	 3,85 x 3,85 m
 13,5 x 1,35 x 0,35 m	 0,00 m
 12,90 m <sup>2</sup>	 EN 1176-1: 2017-12

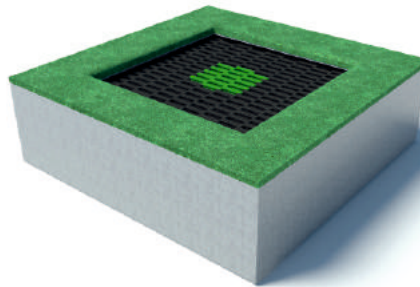

*Choose small trampolines. They are cheaper and safer, because they only fit one child*



EPDM surface ensure fall safety during jumping





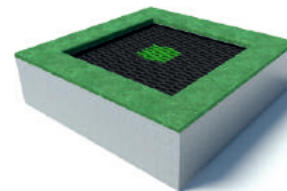
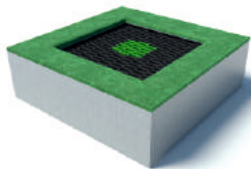



Increased corrosion resistance - stainless steel ropes and fittings



## Trampoline "Mini"





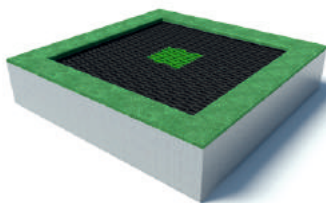

### 1M-T80S

 0,84 x 0,84 m	 3,85 x 3,85 m
 13,5 x 1,35 x 0,35 m	 0,00 m
 12,90 m <sup>2</sup>	 EN 1176-1: 2017-12



## Trampoline "Small"

### 1M-T100S





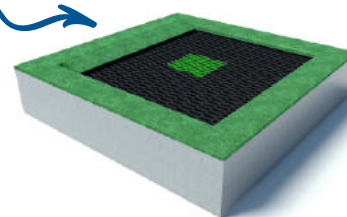

 1,04 x 1,04 m	 4,04 x 4,04 m
 1,55x1,55x0,45 m	 0,00 m
 14,40 m <sup>2</sup>	 EN 1176-1: 2017-12

*Ramp for wheelchair*









## Trampoline "Medium"

### 1M-T125S

 1,29 x 1,29 m	 5,29x5,29 m
 1,80x1,80x0,45 m	 0,00 m
 23,10 m <sup>2</sup>	 EN 1176-1: 2017-12

## Trampoline "Inklusive"

### 1M-T150SI

 1,54 x 1,54 m	 5,54 x 5,54 m
 2,05 x 2,05 x 0,45 m	 0,00 m
 27,30 m <sup>2</sup>	 EN 1176-1: 2017-12



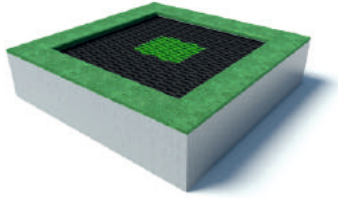

### Trampoline "Big"





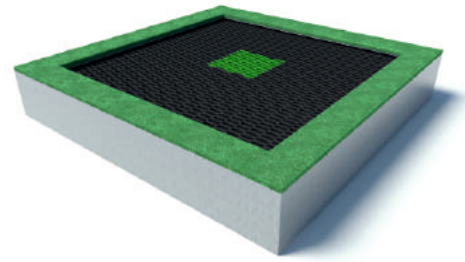

1M-T150S

 1,54 x 1,54 m	 5,54 x 5,54 m
 2,05 x 2,05 x 0,45 m	 HIC 0,00 m
 27,30 m <sup>2</sup>	 NORM EN 1176-1: 2017-12



### Trampoline "Huge one"





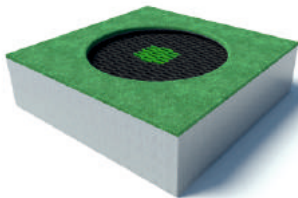

1M-T200S

 2,04 x 2,04 m	 6,04 x 6,04 m
 2,55 x 2,55 x 0,45 m	 HIC 0,00 m
 33,20 m <sup>2</sup>	 NORM EN 1176-1: 2017-12



### Trampoline "Square crater"





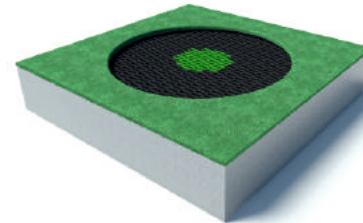

1M-T100RS

 Ø 1,00 m	 Ø 4,01 m
 1,55 x 1,55 x 0,45 m	 HIC 0,00 m
 12,60 m <sup>2</sup>	 NORM EN 1176-1: 2017-12



### Trampoline "Big square crater"

1M-T150RS

 Ø 1,50 m	 Ø 5,56 m
 2,18 x 2,18 x 0,45 m	 HIC 0,00 m
 27,30 m <sup>2</sup>	 NORM EN 1176-1: 2017-12



Long use ensures extremely durable matstroke and thick springs





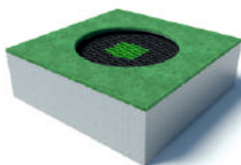

Lifetime warranty for goodhaving fun and jumping!



### Trampoline "Small square crater"





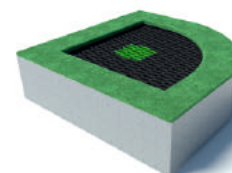

1M-T80RS

 Ø 0,80 m	 Ø 3,80 m
 1,35 x 1,35 x 0,45 m	 HIC 0,00 m
 11,30 m <sup>2</sup>	 NORM EN 1176-1: 2017-12



### Trampoline "Corner"

1M-T1/4R

 Ø 0,00 m	 9,53 x 5,60 m
 6,44x2,60x3,50 m	 HIC 0,00 m
 37,84 m <sup>2</sup>	 NORM EN 1176-1: 2017-12

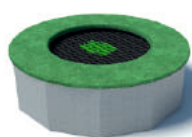

*Teenagers and adults are also like to jump*

## Trampoline "Small crater"

1M-T80R

 Ø 0,84 m	 Ø 3,84 m
 Ø 1,49 m	 HIC 0,00 m
 11,60 m <sup>2</sup>	 NORM EN 1176-1: 2017-12

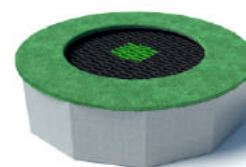

## Trampoline "Crater"

1M-T100R

 Ø 1,04 m	 Ø 4,04 m
 Ø 1,71 m	 HIC 0,00 m
 12,80 m <sup>2</sup>	 NORM EN 1176-1: 2017-12

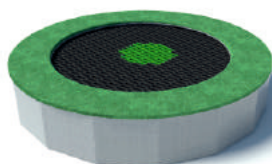

## Trampoline "Big crater"





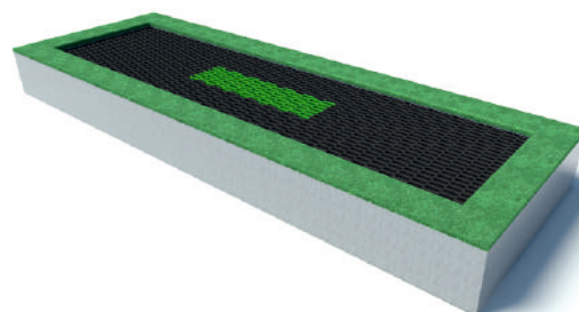

1M-T150R

 Ø 1,57 m	 Ø 5,57 m
 Ø 2,28 m	 HIC 0,00 m
 24,30 m <sup>2</sup>	 NORM EN 1176-1: 2017-12



## Trampoline "Long"

1M-T100x400







 4,01 x 1,04 m	 8,01 x 5,04 m
 4,52 x 1,55 x 0,45 m	 HIC 0,00 m
 36,90 m <sup>2</sup>	 NORM EN 1176-1: 2017-12





Set "Flea"







1M-Set 4

 4 x 1,02x1,02 m	 Ø 5,60 m
 3,00 x 3,00 m	 HIC 0,00 m
 24,80 m <sup>2</sup>	 NORM EN 1176-1: 2017-12



Set "Big Flea"







M1-Set 8

 4x1,04/1,04+4x1,02/1,02 m	 9,53 x 5,60 m
 6,44x2,60x3,50 m	 HIC 0,00 m
 37,84 m <sup>2</sup>	 NORM EN 1176-1: 2017-12



Set "Gerbil"







1M-Set 5

 4,01 x 1,04 m	 9,53 x 5,60 m
 6,44x2,60x3,50 m	 HIC 0,00 m
 37,84 m <sup>2</sup>	 NORM EN 1176-1: 2017-12



Set "Big Eight"







1M-Set 13

 4,01 x 1,04 m	 9,53 x 5,60 m
 6,44x2,60x3,50 m	 HIC 0,00 m
 37,84 m <sup>2</sup>	 NORM EN 1176-1: 2017-12



Set "Craters"

M1-Set 6R







 4,01 x 1,04 m	 9,53 x 5,60 m
 6,44x2,60x3,50 m	 HIC 0,00 m
 37,84 m <sup>2</sup>	 NORM EN 1176-1: 2017-12

*Jehuu!!!  
I'm a  
meerkat :)*



Set "Meerkat"

M1-Set 10







 4,01 x 1,04 m	 9,53 x 5,60 m
 6,44x2,60x3,50 m	 HIC 0,00 m
 37,84 m <sup>2</sup>	 NORM EN 1176-1: 2017-12

## Playground trampolines sets



Set "Grasshopper"







1M-Set5R

 4,01 x 1,04 m	 9,53 x 5,60 m
 6,44x2,60x3,50 m	 0,00 m
 37,84 m <sup>2</sup>	 EN 1176-1: 2017-12



Set "Cat"





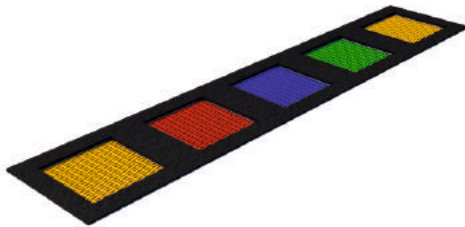

1M-Set 11

 4,01 x 1,04 m	 9,53 x 5,60 m
 6,44x2,60x3,50 m	 0,00 m
 37,84 m <sup>2</sup>	 EN 1176-1: 2017-12



Set "Squirrel"





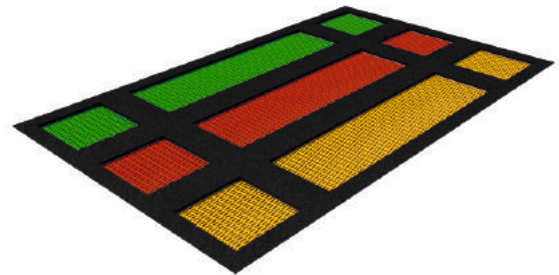

M1-Set 12

 4,01 x 1,04 m	 9,53 x 5,60 m
 6,44x2,60x3,50 m	 0,00 m
 37,84 m <sup>2</sup>	 EN 1176-1: 2017-12



Set "Orangutan"

1M-Set 14

 4,01 x 1,04 m	 9,53 x 5,60 m
 6,44x2,60x3,50 m	 0,00 m
 37,84 m <sup>2</sup>	 EN 1176-1: 2017-12







## Outdoor fitness gyms - OF2 Series

Extremely increased vandal resistance of OF2 devices has made it the most popular series of outdoor gyms. It is characterized by the following advantages: the largest selection of over 20 products and configurations, durable pipes and sheets up to 10 mm thick, non-slip aluminum treads and comfortable seats made of HDPE, stainless screws and washers.

### Performance standards: "MP", "MM"

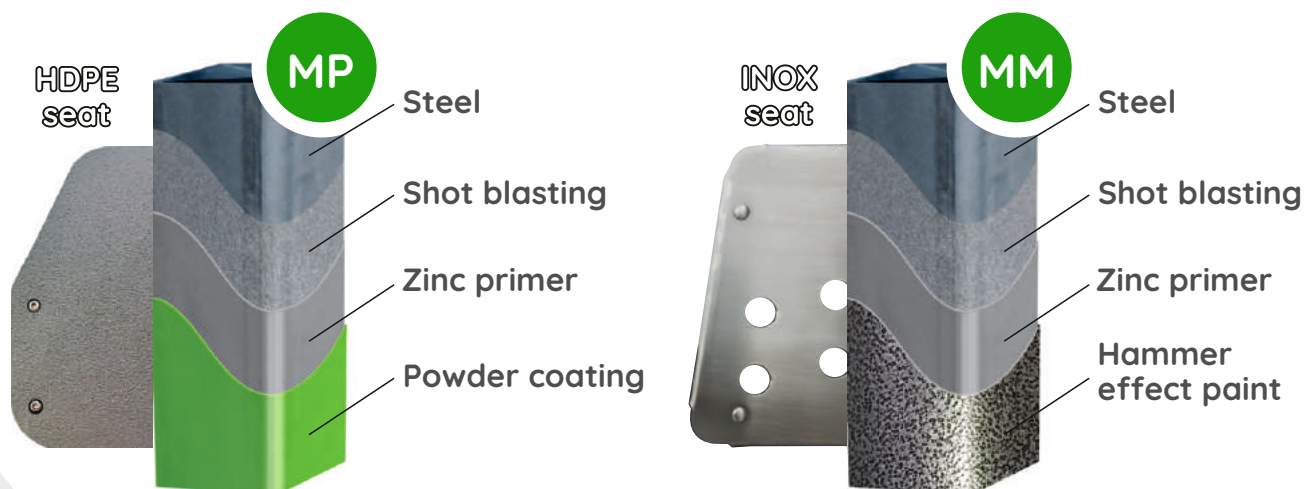

- **MP - Powder coating** powder-coated steel structure, seats made of HDPE, treads made of aluminum.
- **MM - Hammer painting** structure made of steel painted with hammer paint, seats and treads made of stainless steel.



## Outdoor fitness gym - OF2 Series

### Crosstrainer

#### OF2-06

<b>S</b> MP, MM	 4,36 x 3,57 m
 1,36 x 0,57 x 1,59 m	<b>HIC</b> 0,39 m
 13,76 m <sup>2</sup>	<b>NORM</b> EN 16630:2015





You have the choice of two excellent quality standards MP and MM. If you want to additionally improve the resistance to scratches and corrosion, choose painting with hammer paint as well as seats and steps made of stainless steel (PM).



**Premium painting**





<b>S</b> MP, MM	 1,17 x 0,94 x 1,01 m
 14,54 m <sup>2</sup>	 4,17 x 3,94 m
<b>HIC</b> 0,77 m	<b>NORM</b> EN 16630:2015

### Rower

#### OF2-13





<b>S</b> MP, MM	 0,50 x 0,99 x 1,46 m
 12,03 m <sup>2</sup>	 3,50 x 3,99 m
<b>HIC</b> 0,35 m	<b>NORM</b> EN 16630:2015

### Air Walker

#### OF2-01



<b>S</b> MP, MM	 0,94 x 0,81 x 1,15 m
 11,69 m <sup>2</sup>	 3,94 x 3,81 m
<b>HIC</b> 0,30 m	<b>NORM</b> EN 16630:2015

### Gymnastic triangle

#### OF2-10





<b>S</b> MP, MM	 1,68 x 1,09 x 0,60 m
 17,20 m <sup>2</sup>	 4,68 x 4,09 m
<b>HIC</b> 0,50 m	<b>NORM</b> EN 16630:2015

### Double Bench

#### OF2-05





<b>S</b> MP, MM	 1,38 x 1,51 x 0,83 m
 17,85 m <sup>2</sup>	 4,38 x 4,51 m
<b>HIC</b> 0,50 m	<b>NORM</b> EN 16630:2015

### Bench + Back Trainer

#### OF2-05+17



<b>S</b> MP, MM	 1,51 x 0,60 x 0,60 m
 14,35 m <sup>2</sup>	 4,51 x 3,60 m
<b>HIC</b> 0,50 m	<b>NORM</b> EN 16630:2015

### Single Bench

#### OF2-05\_1





S	MP, MM
+	1,83 x 0,88 x 1,78 m
▨	16,88 m <sup>2</sup>
⊞	4,83 x 3,88 m
HIC	0,48 m
NORM	EN 16630:2015

Pull Down + Chest Press

OF2-14+15



S	MP, MM
+	1,71 x 0,70 x 1,78 m
▨	15,56 m <sup>2</sup>
⊞	4,71 x 3,70 m
HIC	0,48 m
NORM	EN 16630:2015

Inclusive Pull Down + Chest Press

OF2-14+15\_i



S	MP, MM
+	1,66 x 0,70 x 1,78 m
▨	15,34 m <sup>2</sup>
⊞	4,66 x 3,70 m
HIC	0,48 m
NORM	EN 16630:2015

Double Chest Press

OF2-15



S	MP, MM
+	1,99 x 0,88 x 1,75 m
▨	17,44 m <sup>2</sup>
⊞	4,99 x 3,88 m
HIC	0,44 m
NORM	EN 16630:2015

Double Pull Down

OF2-14



S	MP, MM
+	1,05 x 0,88 x 1,75 m
▨	13,81 m <sup>2</sup>
⊞	4,05 x 3,88 m
HIC	0,44 m
NORM	EN 16630:2015

Single Pull Down

OF2-14\_1



S	MP, MM
+	2,22 x 0,99 x 1,82 m
▨	21,50 m <sup>2</sup>
⊞	5,22 x 4,49 m
HIC	0,48 m
NORM	EN 16630:2015

Double Butterfly

OF2-18\_2

## Color change



If necessary, you can adjust the color of the device to your needs. Ask your STARMAX sales advisor about the possibility of changing the color.



S	MP, MM
+	0,89 x 0,70 x 1,78 m
▨	12,48 m <sup>2</sup>
⊞	3,89 x 3,70 m
HIC	0,48 m
NORM	EN 16630:2015

Single Chest Press

OF2-15\_1



S	MP, MM
+	1,17 x 0,99 x 1,82 m
▨	16,79 m <sup>2</sup>
⊞	4,17 x 4,49 m
HIC	0,48 m
NORM	EN 16630:2015

Single Butterfly

OF2-18

## Outdoor fitness gym - OF2 Series



S	MP, MM
+	1,17 x 0,90 x 1,25 m
▨	14,34 m <sup>2</sup>
⊕	4,17 x 3,90 m
HIC	0,21 m
NORM	EN 16630:2015

Twister + Ski Trainer

**OF2-11+12**



S	MP, MM
+	0,75 x 1,15 x 1,25 m
▨	13,68 m <sup>2</sup>
⊕	3,75 x 4,15 m
HIC	0,45 m
NORM	EN 16630:2015

Stepper + Hips

**OF2-16+09**

Some parts of the devices may be made of stainless steel or aluminum. Find out more at a STARMAX sales advisor by phone +48 600 250 245



**Too wide range?**



S	MP, MM
+	0,75 x 1,28 x 1,25 m
▨	13,95 m <sup>2</sup>
⊕	3,75 x 4,20 m
HIC	0,45 m
NORM	EN 16630:2015

Ski Trainer + Stepper

**OF2-08+07**



S	MP, MM
+	0,90 x 1,08 x 1,25 m
▨	14,46 m <sup>2</sup>
⊕	3,90 x 4,20 m
HIC	0,21 m
NORM	EN 16630:2015

Ski Trainer + Hips

**OF2-12+09**



S	MP, MM
+	0,90 x 1,13 x 1,25 m
▨	13,82 m <sup>2</sup>
⊕	3,90 x 4,13 m
HIC	0,21 m
NORM	EN 16630:2015

Double Ski Trainer

**OF2-12**



S	MP, MM
+	0,90 x 0,63 x 1,25 m
▨	12,23 m <sup>2</sup>
⊕	3,90 x 3,63 m
HIC	0,21 m
NORM	EN 16630:2015

Single Ski Trainer

**OF2-12\_1**



S	MP, MM
+	0,75 x 0,70 x 1,34 m
▨	11,94 m <sup>2</sup>
⊕	3,75 x 0,70 m
HIC	0,45 m
NORM	EN 16630:2015

Single Stepper

**OF2-16\_1**



S	MP, MM
+	0,75 x 1,28 x 1,34 m
▨	14,12 m <sup>2</sup>
⊕	3,75 x 4,28 m
HIC	0,45 m
NORM	EN 16630:2015

Double Stepper

**OF2-16**





## Outdoor gyms with pylons - OF3 series

Clear, color instructions for use with a pictogram and any configuration of equipment on both sides of the pylon are the basic advantages of this series. For OF3 devices on pylons, choose any free-standing device of the OF2 series in the same colors and add it to set.

### Performance standards: "MP", "MM"



- **MP - Powder coating** powder-coated steel structure, seats made of HDPE, treads made of aluminum.
- **MM - Hammer painting** structure made of steel painted with hammer paint, seats and treads made of stainless steel.



## Outdoor fitness gyms on the pylons - OF3 series

Pull Down + Chest Press

**OF3-09+10**

<b>S</b> MP, MM	 4,70 x 3,88 m
<b>+</b> 1,70 x 0,88 x 1,70 m	<b>HIC</b> 0,44 m
 16,33 m <sup>2</sup>	<b>NORM</b> EN 16630:2015-06





You have the choice of two excellent quality standards MM and MP. If you also want to improve scratch and corrosion resistance, choose hammer paint and stainless seats and steps.



**Premium painting**





<b>S</b> MP, MM	<b>+</b> 0,54 x 0,09 x 1,70 m
 0 m	 0 m
<b>HIC</b> 0 m	<b>NORM</b> EN 16630:2015-06

Pylon

**OF3-01**





<b>S</b> MP, MM	<b>+</b> 0,95 x 0,55 x 1,70 m
 12,09 m <sup>2</sup>	 3,95 x 3,55 m
<b>HIC</b> 0,30 m	<b>NORM</b> EN 16630:2015-06

Legs Raise

**OF3-03**





<b>S</b> MP, MM	<b>+</b> 0,79 x 0,87 x 2,03 m
 12,73 m <sup>2</sup>	 3,79 x 3,87 m
<b>HIC</b> 0,99 m	<b>NORM</b> EN 16630:2015-06

Ladder

**OF3-02**





<b>S</b> MP, MM	<b>+</b> 1,63 x 0,87 x 2,03 m
 15,99 m <sup>2</sup>	 4,63 x 3,87 m
<b>HIC</b> 0,99 m	<b>NORM</b> EN 16630:2015-06

Legs Raise + Ladder

**OF3-03+02**





<b>S</b> MP, MM	<b>+</b> 1,79 x 0,55 x 1,70 m
 15,08 m <sup>2</sup>	 4,79 x 3,55 m
<b>HIC</b> 0,30 m	<b>NORM</b> EN 16630:2015-06

Double Legs Raise

**OF3-03+03**



<b>S</b> MP, MM	<b>+</b> 1,49 x 0,87 x 2,03 m
 15,42 m <sup>2</sup>	 4,49 x 3,87 m
<b>HIC</b> 0,99 m	<b>NORM</b> EN 16630:2015-06

Double Ladder

**OF3-02+02**





S	MP, MM
+	1,03 x 0,54 x 1,70 m
▒	12,35 m <sup>2</sup>
⊕	4,03 x 3,54 m
HIC	0,48 m
NORM	EN 16630:2015-06

Legs Press

OF3-04



S	MP, MM
+	1,97 x 0,54 x 1,70 m
▒	15,66 m <sup>2</sup>
⊕	4,97 x 3,54 m
HIC	0,48m
NORM	EN 16630:2015-06

Double Legs Press

OF3-04+04



S	MP, MM
+	1,60 x 0,80 x 1,70 m
▒	15,56 m <sup>2</sup>
⊕	4,60 x 3,80 m
HIC	0,21 m
NORM	EN 16630:2015-06

Double Ski Trainer

OF3-05+05



S	MP, MM
+	3,73 x 0,94 x 1,70 m
▒	24,58 m <sup>2</sup>
⊕	6,73 x 3,94 m
HIC	0,78 m
NORM	EN 16630:2015-06

Legs Press + Rower

OF3-04+OF2-13



S	MP, MM
+	1,68 x 0,80 x 1,70 m
▒	15,90 m <sup>2</sup>
⊕	4,68 x 3,80 m
HIC	0,21 m
NORM	EN 16630:2015-06

Ski Trainer + Twister

OF3-05+06



S	MP, MM
+	0,85 x 0,80 x 1,70 m
▒	12,70 m <sup>2</sup>
⊕	3,85 x 3,80 m
HIC	0,21 m
NORM	EN 16630:2015-06

Ski Trainer

OF3-05

## Color change



If necessary, you can adjust the color of the device to your needs. Ask your STARMAX sales advisor about the possibility of changing the color.



S	MP, MM
+	1,77 x 0,80 x 1,70 m
▒	16,18 m <sup>2</sup>
⊕	4,77 x 3,80 m
HIC	0,11 m
NORM	EN 16630:2015-06

Double Twister

OF3-06+06



S	MP, MM
+	0,93 x 0,80 x 1,70 m
▒	13,00 m <sup>2</sup>
⊕	3,93 x 3,80 m
HIC	0,11 m
NORM	EN 16630:2015-06

Twister

OF3-06

## Outdoor fitness gyms on the pylons - OF3 series



S	MP, MM
+	1,53 x 0,69 x 1,70 m
▨	14,75 m <sup>2</sup>
⊞	4,53 x 3,69 m
HIC	0,16 m
NORM	EN 16630:2015-06

Double Back Trainer

OF3-07+07



S	MP, MM
+	0,82 x 0,62 x 1,70 m
▨	12,03 m <sup>2</sup>
⊞	3,82 x 3,62 m
HIC	0,16 m
NORM	EN 16630:2015-06

Back Trainer

OF3-07

Extend the warranty up to 5 years using the Starmax mobile service. In addition, you will receive a 10% discount on original spare parts. Order an inspection : [service@starmax.com.pl](mailto:service@starmax.com.pl)



## Inspections and service



S	MP, MM
+	1,26 x 1,51 x 1,70 m
▨	17,30 m <sup>2</sup>
⊞	4,26 x 4,51 m
HIC	0,50 m
NORM	EN 16630:2015-06

Ladder + Back Trainer

OF3-08+07



S	MP, MM
+	0,96 x 1,68 x 1,70 m
▨	16,58 m <sup>2</sup>
⊞	3,96 x 4,68 m
HIC	0,50 m
NORM	EN 16630:2015-06

Double Ladder

OF3-08+08



S	MP, MM
+	0,53 x 1,51 x 1,70 m
▨	13,96 m <sup>2</sup>
⊞	3,53 x 4,51 m
HIC	0,50 m
NORM	EN 16630:2015-06

Bench

OF3-08



S	MP, MM
+	1,87 x 0,88 x 1,70 m
▨	16,97 m <sup>2</sup>
⊞	4,87 x 3,88 m
HIC	0,44 m
NORM	EN 16630:2015-06

Double Pull Down

OF3-09+09



S	MP, MM
+	0,98 x 0,88 x 1,70 m
▨	13,52 m <sup>2</sup>
⊞	3,98 x 3,88 m
HIC	0,44 m
NORM	EN 16630:2015-06

Pull Down

OF3-09



S	MP, MM
+	0,82 x 3,70 x 1,77 m
▨	12,21 m <sup>2</sup>
⊞	3,82 x 3,70 m
HIC	0,48 m
NORM	EN 16630:2015-06

Chest Press

OF3-10





S	MP, MM
+	1,70 x 0,88 x 1,77 m
▨	16,33 m <sup>2</sup>
⊕	4,70 x 3,88 m
HIC	0,44 m
NORM	EN 16630:2015-06

Pull Down + Chest Press

OF3-09+10



S	MP, MM
+	1,96 x 0,80 x 1,86 m
▨	15,90 m <sup>2</sup>
⊕	5,11 x 4,48 m
HIC	0,54 m
NORM	EN 16630:2015-06

Pull Down + Butterfly

OF3-09+15



S	MP, MM
+	1,55 x 0,70 x 1,77 m
▨	14,91 m <sup>2</sup>
⊕	4,55 x 3,70 m
HIC	0,48 m
NORM	EN 16630:2015-06

Double Chest Press

OF3-10+10



S	MP, MM
+	1,75 x 0,80 x 1,86 m
▨	19,78 m <sup>2</sup>
⊕	4,83 x 4,48 m
HIC	0,54 m
NORM	EN 16630:2015-06

Butterfly + Chest Press

OF3-15+10



S	MP, MM
+	1,14 x 1,01 x 1,70 m
▨	14,68 m <sup>2</sup>
⊕	4,14 x 4,01 m
HIC	0,00 m
NORM	EN 16630:2015-06

Small + Big Tai Chi Wheels

OF3-11+12



S	MP, MM
+	1,31 x 1,01 x 1,70 m
▨	15,39 m <sup>2</sup>
⊕	4,31 x 4,01 m
HIC	0,00 m
NORM	EN 16630:2015-06

Double Small Tai Chi Wheels

OF3-11+11

Too much choice?



We will help you choose the optimal exercise and recreation set for your gym free of charge. Your advisor tel. +48 600 250 245



S	MP, MM
+	0,71 x 1,01 x 1,70 m
▨	12,39 m <sup>2</sup>
⊕	3,71 x 4,01 m
HIC	0,00 m
NORM	EN 16630:2015-06

Small Tai Chi Wheels

OF3-11



S	MP, MM
+	0,97 x 0,70 x 1,70 m
▨	12,76 m <sup>2</sup>
⊕	3,97 x 3,70 m
HIC	0,00 m
NORM	EN 16630:2015-06

Double Big Tai Chi Wheels

OF3-12+12

## Outdoor fitness gyms on the pylons - OF3 series



S	MP, MM
+	0,54 x 0,70 x 1,70 m
▨	11,16 m <sup>2</sup>
⊕	3,54 x 3,70 m
HIC	0,00 m
NORM	EN 16630:2015-06

Big Tai Chi Wheel

OF3-12



S	MP, MM
+	0,63 x 0,54 x 1,70 m
▨	0,92 m <sup>2</sup>
⊕	3,63 x 3,54 m
HIC	0,45 m
NORM	EN 16630:2015-06

Stepper

OF3-13

The gym does not require a safe surface. So, you can choose any type of surface for the devices: concrete cubes, overgrowth mats, colored EPDM+SBR, or a plastic geogrid overgrown with lawn.



Safety surface



S	MP, MM
+	1,16 x 0,54 x 1,70 m
▨	12,79 m <sup>2</sup>
⊕	4,16 x 3,54 m
HIC	0,45 m
NORM	EN 16630:2015-06

Double Stepper

OF3-13+13



S	MP, MM
+	1,96 x 0,80 x 1,86 m
▨	21,00 m <sup>2</sup>
⊕	5,11 x 4,48 m
HIC	0,54 m
NORM	EN 16630:2015-06

Double Butterfly

OF3-15+15



S	MP, MM
+	1,03 x 0,80 x 1,86 m
▨	16,47 m <sup>2</sup>
⊕	4,10 x 4,48 m
HIC	0,54 m
NORM	EN 16630:2015-06

Butterfly

OF3-15



S	MP, MM
+	0,85 x 0,80 x 1,70 m
▨	12,71 m <sup>2</sup>
⊕	3,85 x 3,80 m
HIC	0,21 m
NORM	EN 16630:2015-06

Hips

OF3-16



S	MP, MM
+	1,60 x 0,80 x 1,70 m
▨	15,56 m <sup>2</sup>
⊕	4,60 x 3,80 m
HIC	0,21 m
NORM	EN 16630:2015-06

Double Hips

OF3-16+16



S	MP, MM
+	0,82 x 0,06 x 1,70 m
▨	0,0 m
⊕	0,0 x 0,0 m
HIC	0,0 m
NORM	EN 16630:2015-06

Information board

OF3-14



## Outdoor fitness gyms sets 5 in 1 - OF3 series

Pull Down + Legs Press + Ladder  
Stepper + Big Tai Chi Wheel

**OF3-09+04+02+13+12**



**S** MP, MM

**+** 6,44x2,60x3,50 m

**▨** 37,84 m

**⊕** 9,53 x 5,60 m

**HIC** 1,20 m

**NORM** EN 16630:2015-06

*The 5 w 1 device  
will save space  
and money*

Butterfly + Chest Press  
Small Tai Chi Wheels + Legs Raise + Twister

**OF3-15+10+11+03+06**

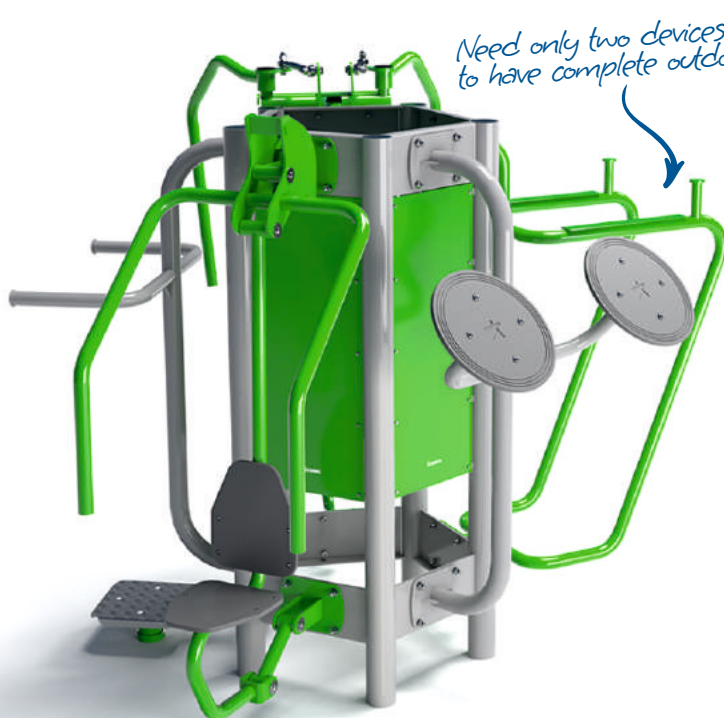

*Need only two devices 5 in 1  
to have complete outdoor gym*



**S** MP, MM

**+** 6,44x2,60x3,50 m

**▨** 37,84 m

**⊕** 9,53 x 5,60 m



**HIC** 1,20 m

**NORM** EN 16630:2015-06





Legs Raise + Chest Press + Twister

**OF3-03+10+06**

<b>S</b> MP, MM	 9,53 x 5,60 m
 6,44x2,60x3,50 m	<b>HIC</b> 1,20 m
 37,84 m	<b>NORM</b> EN 16630:2015-06

Ladder + Pull Down + Legs Press

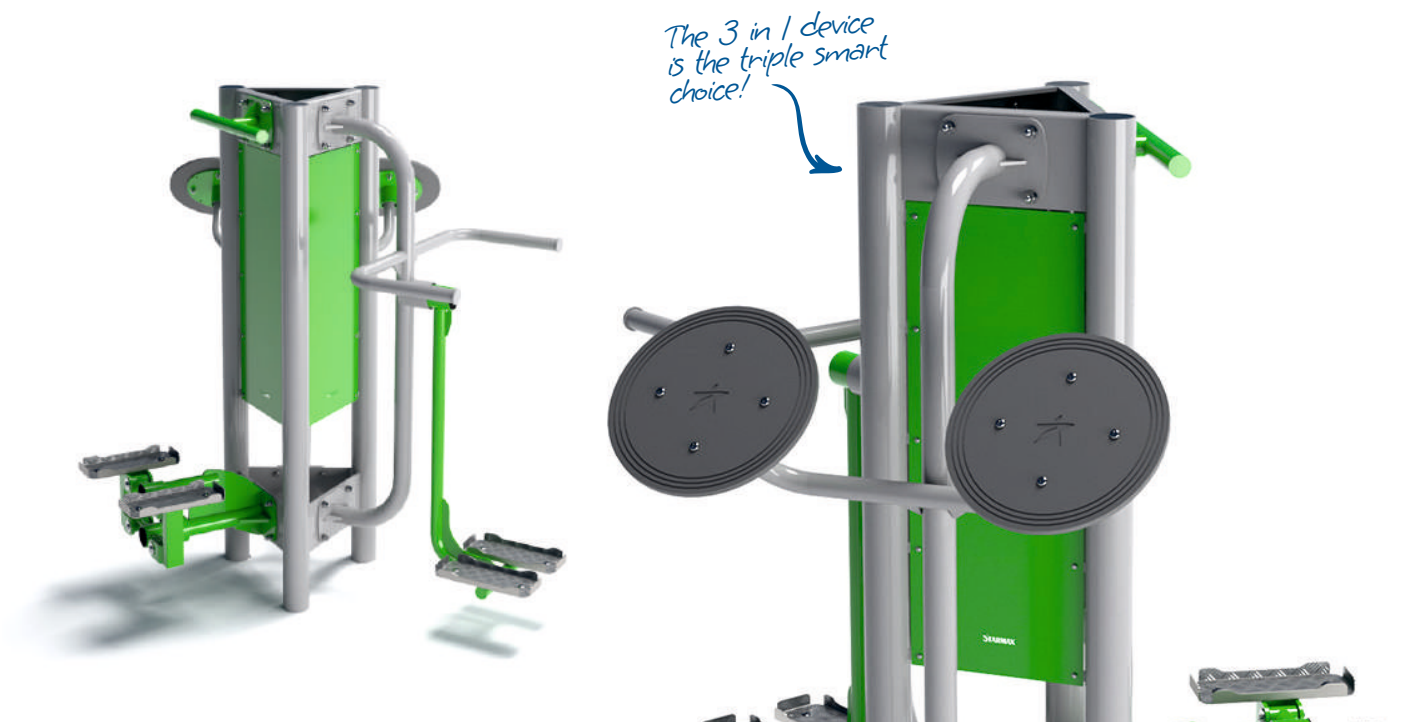

**OF3-02+09+04**

<b>S</b> MP, MM	 9,53 x 5,60 m
 6,44x2,60x3,50 m	<b>HIC</b> 1,20 m
 37,84 m	<b>NORM</b> EN 16630:2015-06



Stepper + Ski Trainer + Small Tai Chi Wheels

**OF3-13+05+11**

<b>S</b> MP, MM	 9,53 x 5,60 m
 6,44x2,60x3,50 m	<b>HIC</b> 1,20 m
 37,84 m	<b>NORM</b> EN 16630:2015-06





## Outdoor gyms - OFC Series

Ask for antique hammer effect paint combined with stainless steel seats and you will see what premium quality gyms look like. Raw colors and a huge, legible instruction perfectly match the modern urban architecture. Freely configure the equipment on both sides of the pylon.

### Performance standards: "MP", "MM"



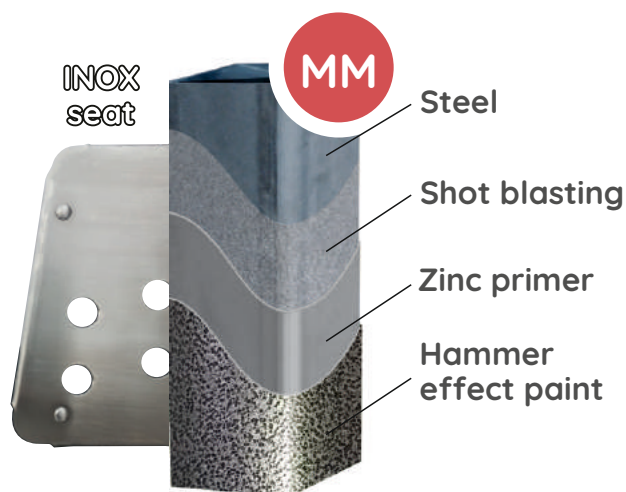
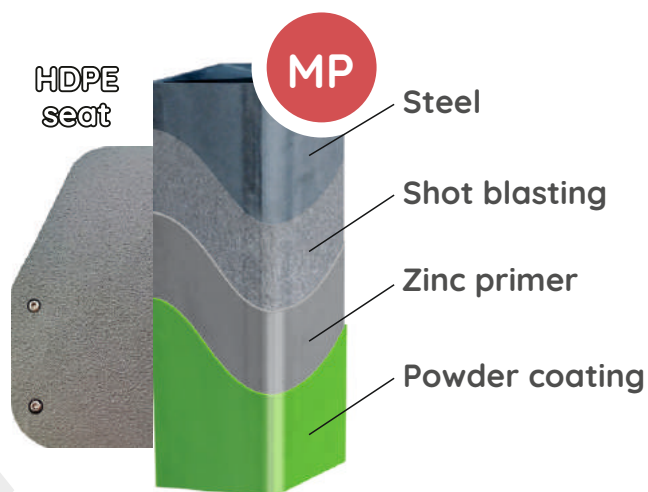



- **MP** - Powder coating powder-coated steel structure, seats made of HDPE, treads made of aluminum.
- **MM** - Hammer painting structure made of steel painted with hammer paint, seats and treads made of stainless steel.



## Outdoor gyms on pylons - OFC Series

### Air Walker + Corsstrainer

#### OFC-02+05

 MP, MM	 6,56 x 4,32 m
 3,56 x 1,32 x 1,77 m	 0,38 m
 26,43 m <sup>2</sup>	 EN 16630:2015









You have a choice of two additional quality standards MM and MP. If you also want to get damage resistance and choose hammer paint as well as stainless steel seats and steps.



**Premium painting**









 MP, MM	 0,54 x 0,09 x 1,77 m
 0,00 m <sup>2</sup>	 0,00 x 0,00 m
 0,00 m	 EN 16630:2015

### Pylon

#### OFC-01









 MP, MM	 0,55 x 1,32 x 1,52 m
 13,40 m <sup>2</sup>	 3,55 x 4,32 m
 0,34 m	 EN 16630:2015

### Air Walker

#### OFC-02









 MP, MM	 1,35 x 0,63 x 1,58 m
 13,84 m <sup>2</sup>	 4,35 x 3,63 m
 0,38 m	 EN 16630:2015

### Crosstariner

#### OFC-05









 MP, MM	 1,49 x 3,87 x 1,92 m
 15,44 m <sup>2</sup>	 4,49 x 3,87 m
 0,92 m	 EN 16630:2015

### Double Ladder

#### OFC-03+03









 MP, MM	 0,79 x 0,87 x 1,92 m
 12,74 m <sup>2</sup>	 3,79 x 3,87 m
 0,92 m	 EN 16630:2015

### Single Ladder

#### OFC-03



 MP, MM	 1,54 x 0,87 x 1,92 m
 15,65 m <sup>2</sup>	 4,54 x 3,87 m
 0,92 m	 EN 16630:2015

### Legs raise + Ladder

#### OFC-06+03





Double Bench

OFC-04+04

S	MP, MM
+	0,97 x 1,79 x 1,77 m
▨	17,04 m <sup>2</sup>
⊕	3,97 x 4,79 m
HIC	0,50 m
NORM	EN 16630:2015



Single Bench

OFC-04

S	MP, MM
+	0,53 x 1,57 x 1,77 m
▨	14,24 m <sup>2</sup>
⊕	3,53 x 4,57 m
HIC	0,50 m
NORM	EN 16630:2015



Bench + Back Trainer

OFC-04+08

S	MP, MM
+	1,22 x 1,57 x 1,77 m
▨	17,42 m <sup>2</sup>
⊕	4,22 x 4,57 m
HIC	0,50 m
NORM	EN 16630:2015



Double Back Trainer

OFC-08+08

S	MP, MM
+	1,53 x 0,82 x 1,77 m
▨	15,36 m <sup>2</sup>
⊕	4,53 x 3,82 m
HIC	0,26 m
NORM	EN 16630:2015



Single Legs Raise

OFC-06

S	MP, MM
+	0,84 x 0,55 x 1,77 m
▨	14,39 m <sup>2</sup>
⊕	3,84 x 3,55 m
HIC	0,29 m
NORM	EN 16630:2015

*Choose the standard of workmanship!*



Double Legs Raise

OFC-06+06

S	MP, MM
+	1,60 x 0,55 x 1,77 m
▨	11,72 m <sup>2</sup>
⊕	4,60 x 3,55 m
HIC	0,29 m
NORM	EN 16630:2015

## Landscape projects



Design of an external actuator and playgrounds to permissions to create or use uninsured software. Call now: +48 602 323 104 landscape architect.



Single Legs Press

OFC-07

S	MP, MM
+	0,95 x 0,59 x 1,77 m
▨	12,29 m <sup>2</sup>
⊕	3,95 x 3,59 m
HIC	0,48 m
NORM	EN 16630:2015



Double Legs Press

OFC-07+07

S	MP, MM
+	1,81 x 0,59 x 1,77 m
▨	15,32 m <sup>2</sup>
⊕	4,81 x 3,59 m
HIC	0,48 m
NORM	EN 16630:2015

## Outdoor gyms on pylons - OFC Series

Stainless or HDPE seats



S	MP, MM
+	2,72 x 0,94 x 1,77 m
▨	20,62 m <sup>2</sup>
⊕	5,72 x 3,94 m
HIC	0,77 m
NORM	EN 16630:2015

Rower + Legs Press

**OFC-11+07**



S	MP, MM
+	1,30 x 0,89 x 1,47 m
▨	14,81 m <sup>2</sup>
⊕	4,30 x 3,89 m
HIC	0,21 m
NORM	EN 16630:2015

Twister + Ski Trainer

**OFC-09+10**

Extend the warranty up to 5 years using the STARMAX mobile service. In addition, you will receive a 10% discount on original spare parts. Order an inspection service@starmax.com.pl



## Inspections and service



S	MP, MM
+	1,22 x 0,54 x 1,47 m
▨	12,97 m <sup>2</sup>
⊕	4,22 x 0,54 m
HIC	0,11 m
NORM	EN 16630:2015

Double Twister

**OFC-09\_1**

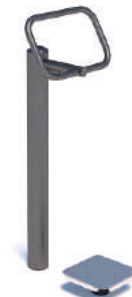

S	MP, MM
+	0,67 x 0,53 x 1,47 m
▨	11,02 m <sup>2</sup>
⊕	3,67 x 3,53 m
HIC	0,11 m
NORM	EN 16630:2015

Single Twister

**OFC-09**



S	MP, MM
+	0,80 x 0,89 x 1,35 m
▨	12,86 m <sup>2</sup>
⊕	3,80 x 3,89 m
HIC	0,21 m
NORM	EN 16630:2015

Single Ski Trainer

**OFC-10**



S	MP, MM
+	1,40 x 0,89 x 1,35 m
▨	15,18 m <sup>2</sup>
⊕	4,40 x 3,89 m
HIC	0,21 m
NORM	EN 16630:2015

Double Ski Trainer

**OFC-10\_1**



S	MP, MM
+	1,18 x 0,94 x 1,01 m
▨	14,54 m <sup>2</sup>
⊕	4,18 x 3,94 m
HIC	0,77 m
NORM	EN 16630:2015

Rower

**OFC-11**



S	MP, MM
+	0,97 x 0,54 x 1,13 m
▨	11,73 m <sup>2</sup>
⊕	3,97 x 3,54 m
HIC	0,70 m
NORM	EN 16630:2015

Bicycle

**OFC-18**





Double Pull Down

OFC-12+12

S	MP, MM
+	1,93 x 0,88 x 1,77 m
▨	17,21 m <sup>2</sup>
⊕	4,93 x 3,88 m
HIC	0,44 m
NORM	EN 16630:2015



Single Pull Down

OFC-12

S	MP, MM
+	1,01 x 0,88 x 1,77 m
▨	13,62 m <sup>2</sup>
⊕	4,01 x 3,88 m
HIC	0,44 m
NORM	EN 16630:2015



Pull Down + Chest Press

OFC-12+13

S	MP, MM
+	1,79 x 0,88 x 1,77 m
▨	16,66 m <sup>2</sup>
⊕	4,79 x 3,88 m
HIC	0,44 m
NORM	EN 16630:2015



Double Chest Press

OFC-13+13

S	MP, MM
+	1,64 x 0,84 x 1,77 m
▨	15,88 m <sup>2</sup>
⊕	3,64 x 3,84
HIC	0,36 m
NORM	EN 16630:2015



Single Chest Press

OFC-13

S	MP, MM
+	0,86 x 0,84 x 1,77 m
▨	12,91 m <sup>2</sup>
⊕	3,86 x 3,84 m
HIC	0,36 m
NORM	EN 16630:2015



Massager

OFC-17

S	MP, MM
+	0,97 x 0,65 x 1,56 m
▨	12,57 m <sup>2</sup>
⊕	3,97 x 3,65 m
HIC	0,00 m
NORM	EN 16630:2015

Too much choice?



We will help you choose the optimal exercise and recreation set for your gym free of charge. Your advisor tel. +48 884 000 884



Skier

OFC-19

S	MP, MM
+	1,45 x 0,59 x 1,64 m
▨	15,88 m <sup>2</sup>
⊕	4,95 x 3,59 m
HIC	0,24 m
NORM	EN 16630:2015



Information board

OFC-14

S	MP, MM
+	0,51 x 0,06 x 1,78 m
▨	0,00 m <sup>2</sup>
⊕	0,00 x 0,00 m
HIC	0,00 m
NORM	EN 16630:2015



# WE CREATE THE WORLD OF OUTDOOR PHYSICAL ACTIVITY

PONAD  
10 000  
PROJEKTÓW



100%  
POLSKI  
PRODUKT







## Outdoor gyms - OFM Series

The OFM series outdoor gym is equipment characterized by a unique design. A lot of bends give the equipment a light and eye-pleasing shape. The uniqueness of the devices is emphasized by the unique orange and graphite colors that beautifully fit into the urban modern architecture.

As a manufacturer of outdoor gyms, we put emphasis on ergonomics and reliability. A characteristic feature of OFM are the bends of the main structural pipe (with a cross-section of  $\varnothing$  88.9 mm) in its upper part. Standard seats are made of 10 mm hdpe. Steel handles with rounded ends. Aluminum footers guarantee aesthetics for many

years of intensive use. Stainless mushroom head screws emphasize the high quality. Powder coating with a zinc-rich primer guarantees long-term anti-corrosion protection.



The devices we offer are solid, reliable, resistant to damage and perfectly suited to our weather conditions. They perfectly fit into the development of public spaces, e.g. parks, schools, kindergartens, playgrounds, beaches and housing estates.

We will be happy to help you plan your local Fitness Park!

## Outdoor gyms - Seria OFM

### Bicycle Active

#### OFM-15

<b>S</b> MP, MM	 4,04 x 3,67 m
<b>+</b> 1,04 x 0,67 x 1,49 m	<b>HIC</b> 0,79 m
 12,85 m <sup>2</sup>	<b>NORM</b> EN 16630:2015-06





In our team, the support of a landscape designer is waiting for you. Construction project or on application? We're starting now!  
Write to us : [projekty@starmax.com.pl](mailto:projekty@starmax.com.pl)



### Gym design





<b>S</b> MP, MM	 4,02 x 3,56 m
<b>+</b> 3,02 x 0,56 x 1,40 m	<b>HIC</b> 1,77 m
 12,35 m <sup>2</sup>	<b>NORM</b> EN 16630:2015-06

### Air Walker

#### OFM-17





<b>S</b> MP, MM	 3,96 x 3,80 m
<b>+</b> 0,96 x 0,80 x 1,43 m	<b>HIC</b> 0,19 m
 13,12 m <sup>2</sup>	<b>NORM</b> EN 16630:2015-06

### Ski Trainer

#### OFM-18





<b>S</b> MP, MM	 4,15 x 3,55 m
<b>+</b> 1,15 x 0,55 x 1,55 m	<b>HIC</b> 0,48 m
 12,78 m <sup>2</sup>	<b>NORM</b> EN 16630:2015-06

### Legs Press

#### OFM-07





<b>S</b> MP, MM	 4,07 x 3,80 m
<b>+</b> 1,07 x 0,80 x 0,79 m	<b>HIC</b> 0,56 m
 13,53 m <sup>2</sup>	<b>NORM</b> EN 16630:2015-06

### Rower

#### OFM-09





<b>S</b> MP, MM	 4,04 x 3,67 m
<b>+</b> 1,04 x 0,67 x 1,32 m	<b>HIC</b> 0,79 m
 12,85 m <sup>2</sup>	<b>NORM</b> EN 16630:2015-06

### Bicycle

#### OFM-16



<b>S</b> MP, MM	 4,05 x 3,54 m
<b>+</b> 1,05 x 0,54 x 1,49 m	<b>HIC</b> 0,41 m
 12,40 m <sup>2</sup>	<b>NORM</b> EN 16630:2015-06

### Crosstrainer

#### OFM-12





S	MP, MM
+	1,26 x 0,63 x 1,08 m
▨	13,53 m <sup>2</sup>
⊕	4,26 x 3,63 m
HIC	0,65 m
NORM	EN 16630:2015-06

Rider

OFM-08



S	MP, MM
+	1,90 x 0,54 x 1,45 m
▨	15,41 m <sup>2</sup>
⊕	4,90 x 3,54 m
HIC	0,25 m
NORM	EN 16630:2015-06

Double Skier

OFM-13



S	MP, MM
+	1,28 x 0,54 x 1,45 m
▨	13,21 m <sup>2</sup>
⊕	4,28 x 3,54 m
HIC	0,25 m
NORM	EN 16630:2015-06

Single Skier

OFM-14



S	MP, MM
+	1,93 x 1,93 x 1,24 m
▨	19,10 m <sup>2</sup>
⊕	4,93 X 4,93 m
HIC	0,19 m
NORM	EN 16630:2015-06

Triple Twister

OFM-21



S	MP, MM
+	0,94 x 0,72 x 1,99 m
▨	12,80 m <sup>2</sup>
⊕	3,94 x 3,72 m
HIC	0,58 m
NORM	EN 16630:2015-06

Stepper Plus

OFM-11



S	MP, MM
+	0,94 x 0,72 x 1,99 m
▨	12,80 m <sup>2</sup>
⊕	3,94 x 3,72 m
HIC	0,58 m
NORM	EN 16630:2015-06

Stepper

OFM-10

## Inspections and service



Extend the warranty up to 5 years using the Starmax mobile service. In addition, you will receive a 10% discount on original spare parts. Inspection of the outdoor gym in accordance with the maintenance manual.



S	MP, MM
+	0,94 x 1,00 x 1,55 m
▨	13,72 m <sup>2</sup>
⊕	3,94 x 3,00 m
HIC	0,46 m
NORM	EN 16630:2015-06

Butterfly (pull inside)

OFM-03



S	MP, MM
+	1,10 x 0,67 x 1,55 m
▨	13,12 m <sup>2</sup>
⊕	4,10 x 3,67 m
HIC	0,67 m
NORM	EN 16630:2015-06

Butterfly (push out)

OFM-06

## Outdoor gyms - Seria OFM



S	MP, MM
+	1,10 x 0,79 x 1,55 m
▨	13,64 m <sup>2</sup>
⊕	4,10 x 3,79 m
HIC	0,42 m
NORM	EN 16630:2015-06

Vertical Press

**OFM-01**



S	MP, MM
+	1,03 x 0,79 x m
▨	13,35 m <sup>2</sup>
⊕	4,03 x 3,79 m
HIC	0,43 m
NORM	EN 16630:2015-06

Pull Down

**OFM-04**

We will help you choose the optimal exercise and recreation set for your gym free of charge.  
Your advisor phone number : +48 884 000 884



**Too wide offer range?**



S	MP, MM
+	1,10 x 0,79 x 1,55 m
▨	13,61 m <sup>2</sup>
⊕	4,10 x 3,79 m
HIC	0,43 m
NORM	EN 16630:2015-06

Seating Pull

**OFM-05**



S	MP, MM
+	1,03 x 0,79 x 1,55 m
▨	13,37 m <sup>2</sup>
⊕	4,03 x 3,79 m
HIC	0,46 m
NORM	EN 16630:2015-06

Seating Press

**OFM-02**



S	MP, MM
+	0,55 x 0,61 x 0,82 m
▨	10,89 m <sup>2</sup>
⊕	3,55 x 3,61 m
HIC	0,24 m
NORM	EN 16630:2015-06

Back Trainer

**OFM-24**



S	MP, MM
+	1,32 x 0,36 x 0,45 m
▨	12,56 m <sup>2</sup>
⊕	4,32 x 3,36 m
HIC	0,45 m
NORM	EN 16630:2015-06

Bench

**OFM-25**



S	MP, MM
+	1,30 x 0,84 x 1,38 m
▨	14,49 m <sup>2</sup>
⊕	4,30 x 3,84 m
HIC	0,24 m
NORM	EN 16630:2015-06

Surfer

**OFM-19**



S	MP, MM
+	0,54 x 0,06 x 1,88 m
▨	0,00 m <sup>2</sup>
⊕	0,00 x 0,00 m
HIC	0,00 m
NORM	EN 16630:2015-06

Information board

**OFM-30**



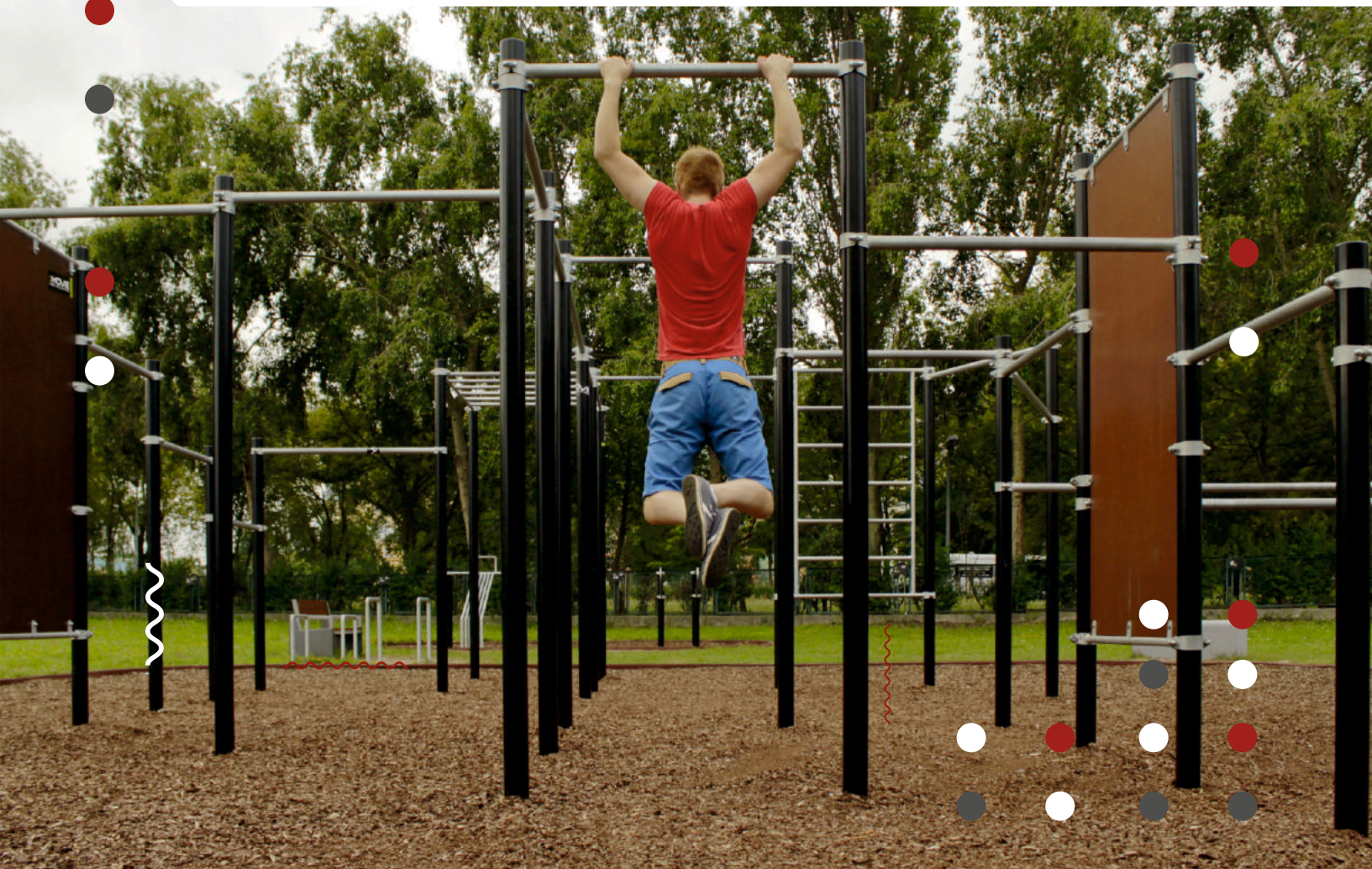

## Street Workout & Parkour Bodyweight exercise equipment

Street workout is nothing more than strength training based on exercises using your own body weight, calisthenic training based on gymnastic exercises. They are done outdoors, not in the gym. Calisthenics exercises have been known since ancient times and were practiced mainly by soldiers. However, for many years, exercises with your own body weight have also been a complementary training to many sports. We are one of the first manufacturers of this type of equipment in Poland. We operate mainly for young people who want to take care of their figure and fitness, not necessarily spending time in a traditional gym.

Street workout & Parkour devices give users the opportunity to return to the old "health paths" that allowed for a diverse and creative training.

Street Workout Starmax devices are robust and resistant to various weather conditions. The poles can be made of powder-coated, galvanized or stainless steel, while the poles are made of hot-dip galvanized steel or stainless steel. Thanks to system solutions, Street Workout Starmax devices can be combined into sets of any functionality and size.

Workout equipment and sets designed in accordance with the PN-EN 1176-1:2017-12 and PN-EN 16630:2015 standards.

## Street Workout Sets

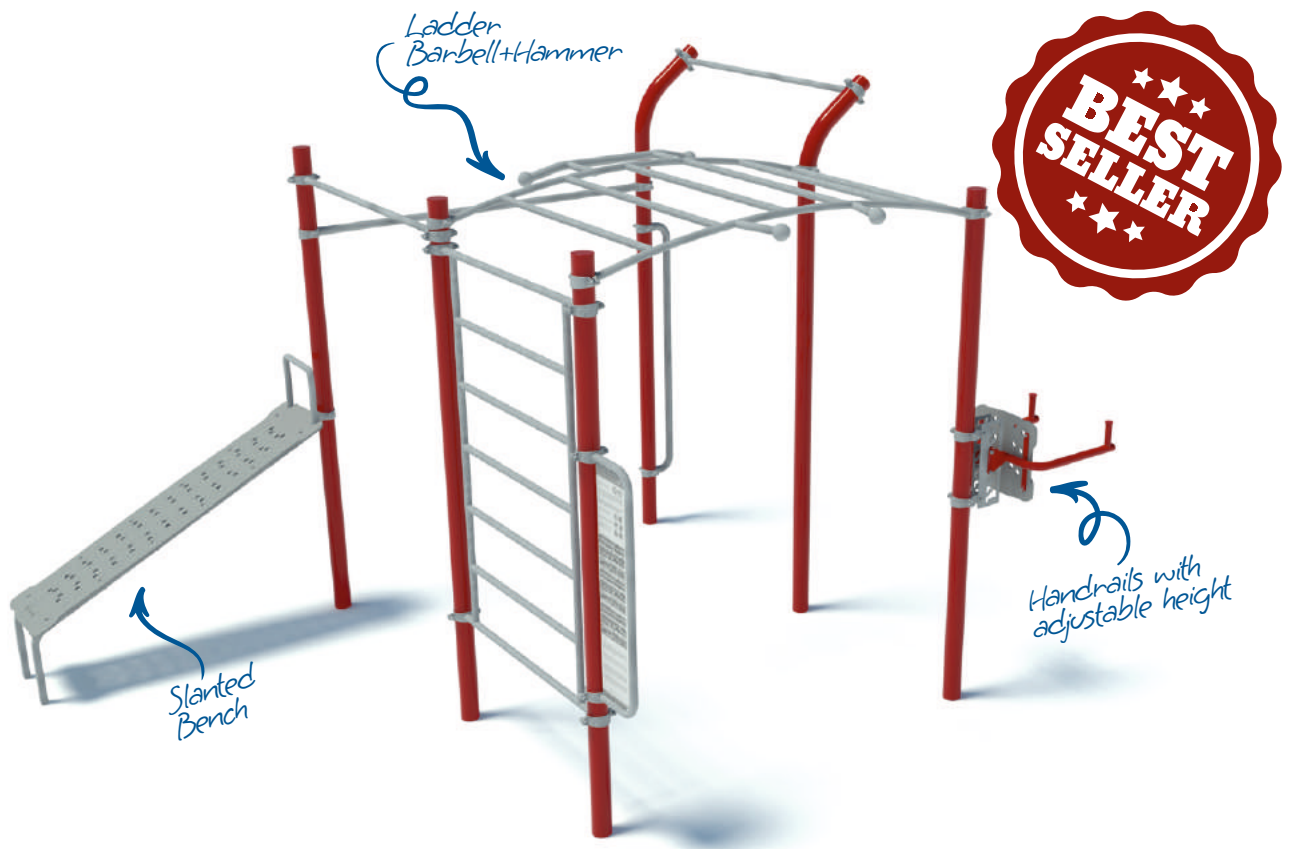

### Set "Flag"

Set - S11

<b>S</b>	PM, MM, I		9,53 x 5,60 m
<b>+</b>	6,44x2,60x3,50 m	<b>HIC</b>	1,20 m
	37,84 m	<b>NORM</b>	EN 16630:2015-06 EN 1176-1:2017-12

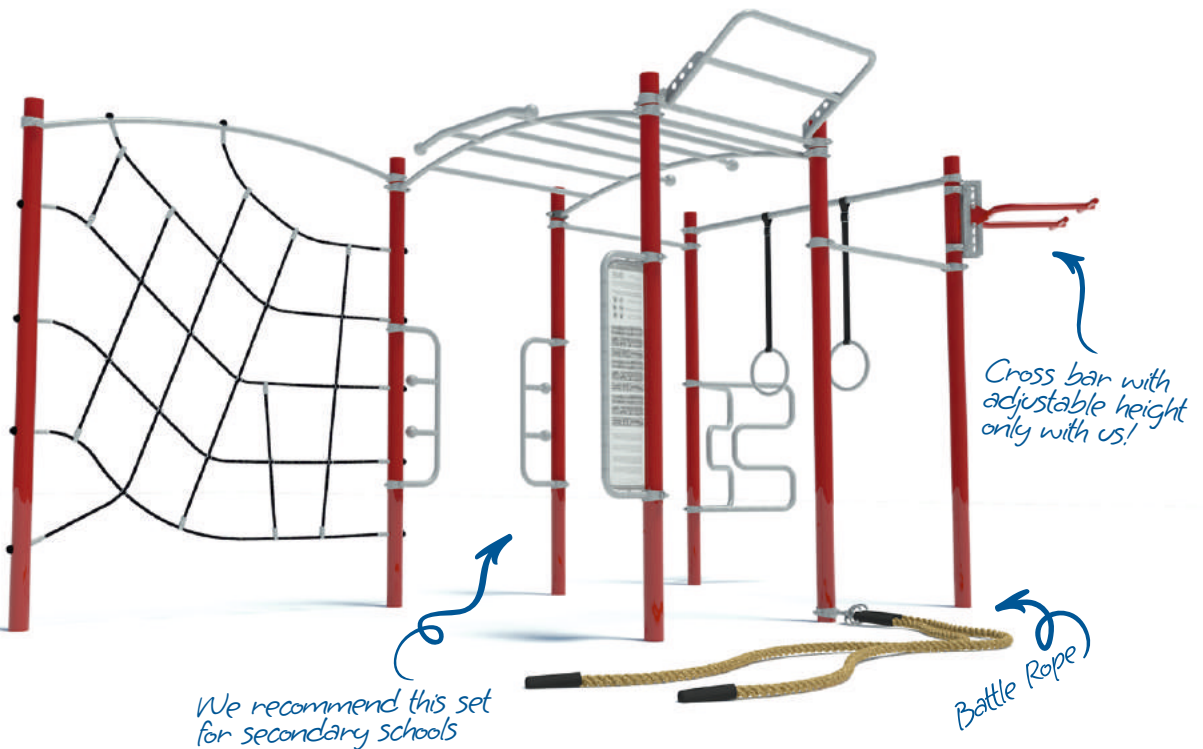

### Set "StrongMax"

Set - S12





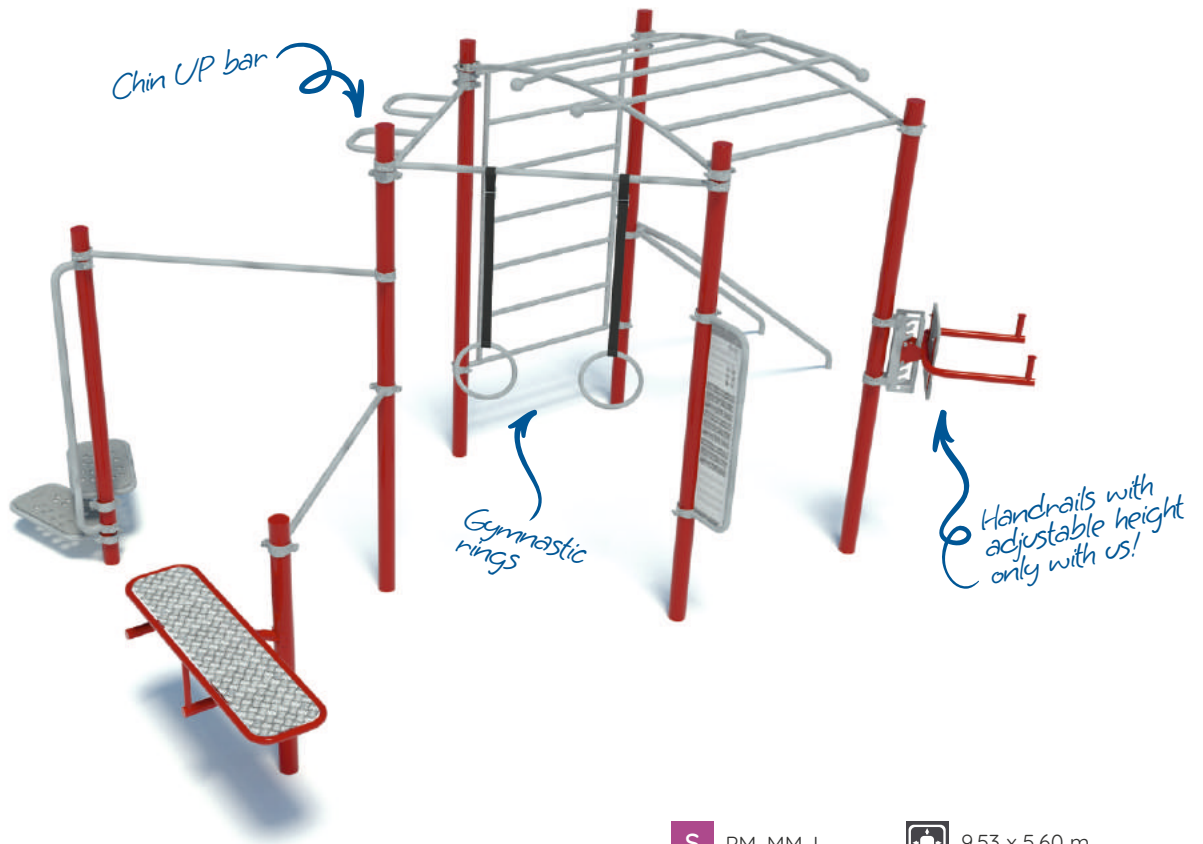

<b>S</b>	PM, MM, I		9,53 x 5,60 m
<b>+</b>	6,44x2,60x3,50 m	<b>HIC</b>	1,20 m
	37,84 m	<b>NORM</b>	EN 16630:2015-06 EN 1176-1:2017-12





Set "6Pack"





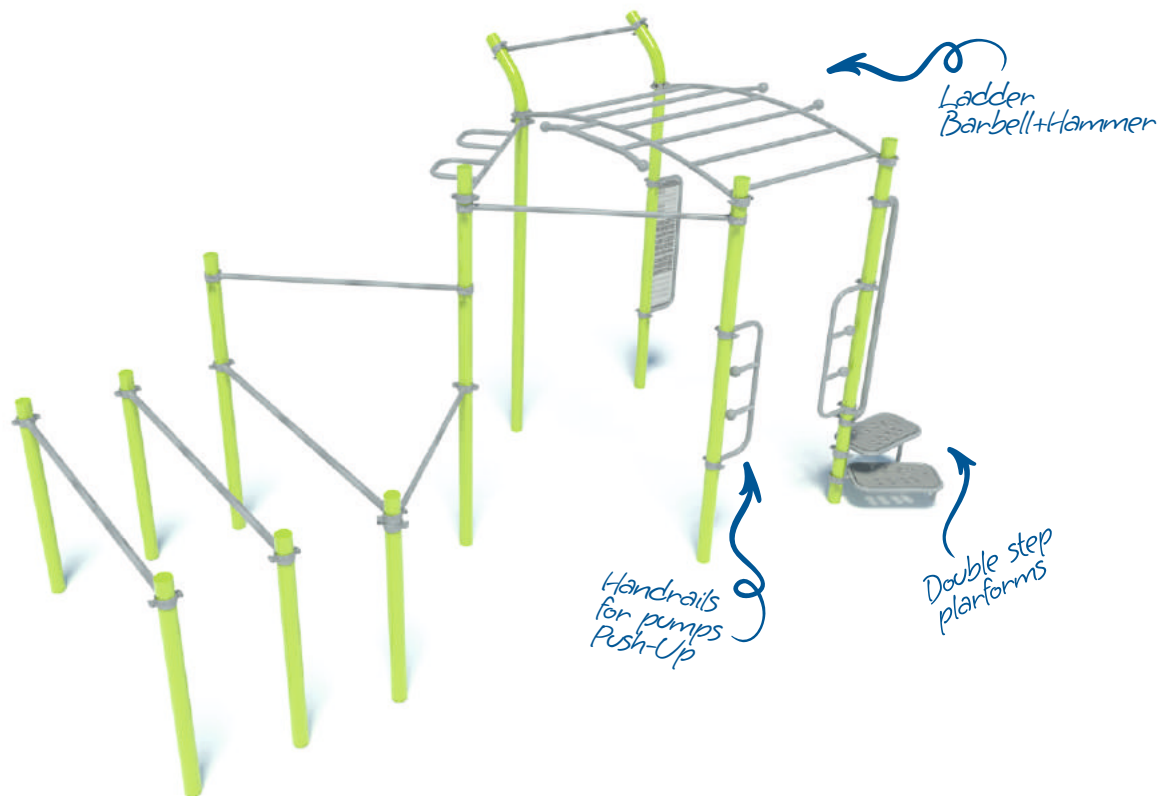

Set - S13

 PM, MM, I	 9,53 x 5,60 m
 6,44x2,60x3,50 m	 1,20 m
 37,84 m	 EN 16630:2015-06 EN 1176-1:2017-12



Set "T-Rex"





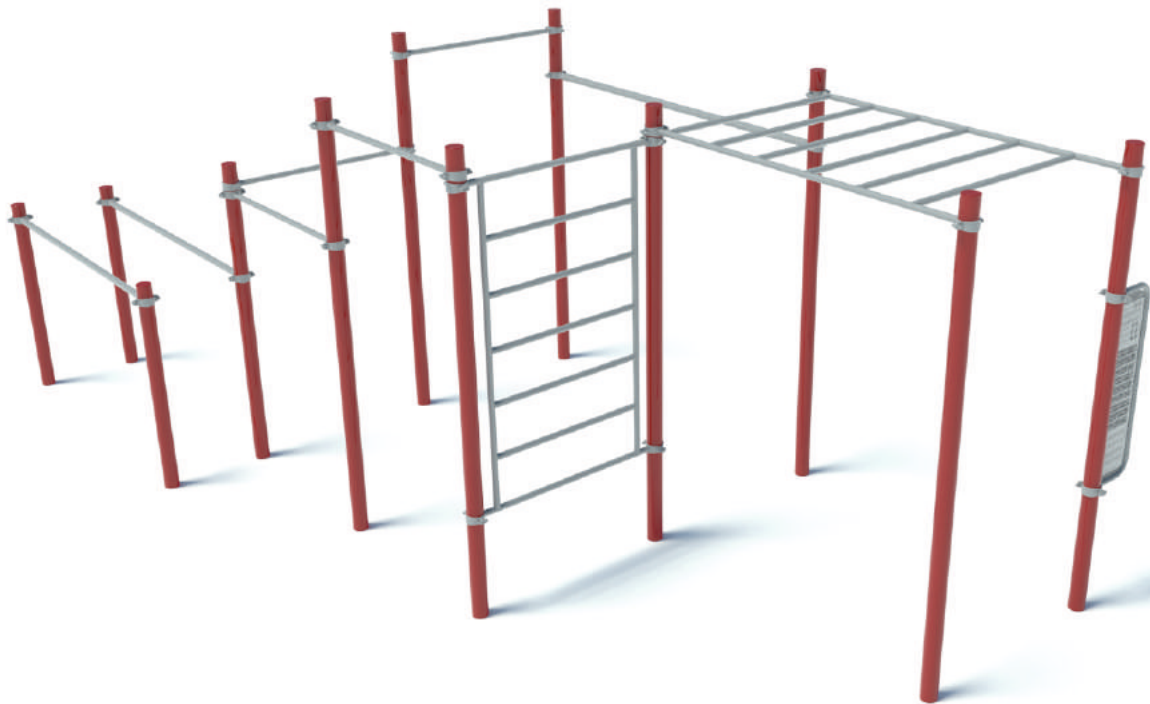

Set - S14

 PM, MM, I	 9,53 x 5,60 m
 6,44x2,60x3,50 m	 1,20 m
 37,84 m	 EN 16630:2015-06 EN 1176-1:2017-12



Set "Start"





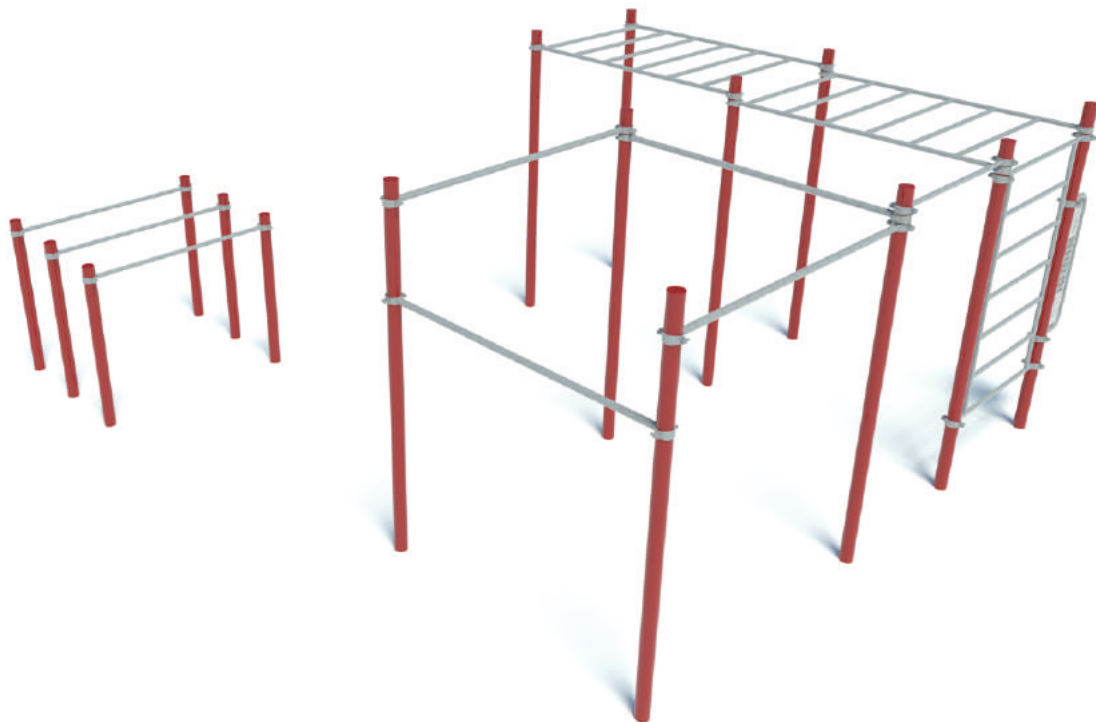

Set - S15

 PM, MM, I	 9,53 x 5,60 m
 6,44x2,60x3,50 m	 1,20 m
 37,84 m	 EN 16630:2015-06 EN 1176-1:2017-12



Set "Medium"

Set - S16







 PM, MM, I	 9,53 x 5,60 m
 6,44x2,60x3,50 m	 1,20 m
 37,84 m	 EN 16630:2015-06 EN 1176-1:2017-12





**Set "Full"**

**Set - S11**





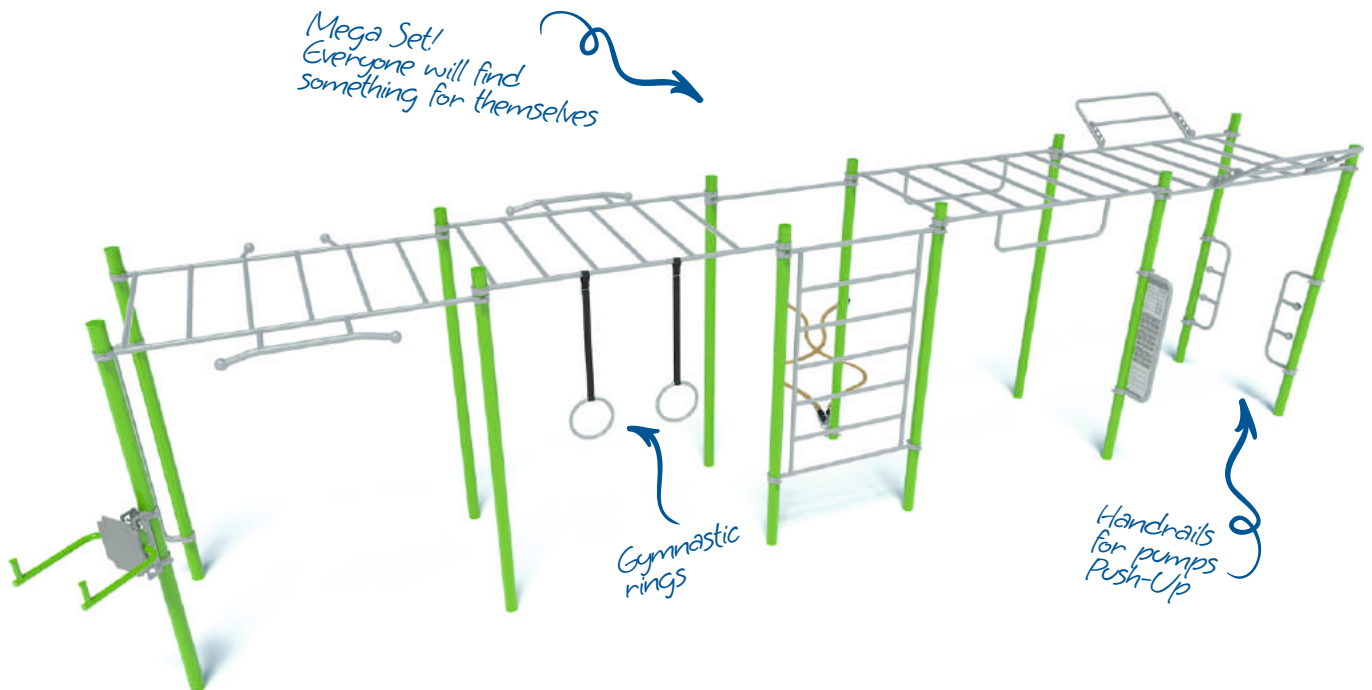

 PM, MM, I	 9,53 x 5,60 m
 6,44x2,60x3,50 m	 1,20 m
 37,84 m	 EN 16630:2015-06 EN 1176-1:2017-12

*Mega Set!  
Everyone will find  
something for themselves*



**Set "Crossfit station "**

**Set - S10**

 PM, MM, I	 9,53 x 5,60 m
 6,44x2,60x3,50 m	 1,20 m
 37,84 m	 EN 16630:2015-06 EN 1176-1:2017-12

## Single devices



S	PM, MM, I
+	1,30 x 0,16 x 2,50 m
▨	20,17 m <sup>2</sup>
⊕	3,40 x 2,26 m
HIC	2,40 m
NORM	EN 16630:2015-06 EN 1176-1:2017-12



S	PM, MM, I
+	1,60 x 1,36 x 0,80 m
▨	18,13 m <sup>2</sup>
⊕	4,60 x 4,36 m
HIC	0,70 m
NORM	EN 16630:2015-06 EN 1176-1:2017-12

Vertical ladder

**Set: 2xSW-2 + 1xSW10**

Inclusive parallel bars

**Set: 4xSW-4 + 1xSW-76**



S	PM, MM, I
+	2,10 x 2,15 x 2,70 m
▨	26,90 m <sup>2</sup>
⊕	5,38 x 5,43 m
HIC	1,70 m
NORM	EN 16630:2015-06 EN 1176-1:2017-12



S	PM, MM, I
+	2,10 x 1,76 x 2,50 m
▨	22,34 m <sup>2</sup>
⊕	5,10 x 4,76 m
HIC	1,50 m
NORM	EN 16630:2015-06 EN 1176-1:2017-12

Horizontal ladder "Ladder Up"

**Set: 4xSW-2 + 1xSW-16**

Arched ladder "Barbell+Hammer"

**Set: 4xSW-2 + 1xSW-17**

Ask us about street workout sets in a stainless version or painted poles and stainless steel exercise elements. As a standard, we guarantee excellent resistance to scratches and corrosion by hot-dip tinning of all exercise elements.



**Performance standards**



S	PM, MM, I
+	2,10 x 1,36 x 2,50 m
▨	20,31 m <sup>2</sup>
⊕	5,10 x 4,36 m
HIC	1,50 m
NORM	EN 16630:2015-06 EN 1176-1:2017-12



S	PM, MM, I
+	2,29 x 2,51 x 3,44 m
▨	21,70 m <sup>2</sup>
⊕	5,76 x 5,51 m
HIC	2,20 m
NORM	EN 16630:2015-06 EN 1176-1:2017-12

Horizontal ladder "Overhang"

**Set: 4xSW-2 + 1xSW-15**

Mini set "Rope + High bars"

**Set: 3xSW-2 + 1xSW-8**





S	PM, MM, I
+	2,10 x 0,76 x 1,30 m
▨	17,24 m <sup>2</sup>
⊕	5,10 x 3,76 m
HIC	1,20 m
NORM	EN 16630:2015-06 EN 1176-1:2017-12

Parallel bars

**Set: 4xSW-4 + 2xSW-21**



S	PM, MM, I
+	2,07 x 0,77 x 1,30 m
▨	17,14 m <sup>2</sup>
⊕	5,07 x 3,77 m
HIC	1,20 m
NORM	EN 16630:2015-06 EN 1176-1:2017-12

Slanted bars

**Set: 2xSW-4 + 1xSW-33**

## Safety surfaces



When installing the equipment, we will make a safe surface. Choose the type of surface that suits you best: EPDM+SBR is the highest aesthetics and expression of colors, gravel, washed sand, bark, colored wood chips.



S	PM, MM, I
+	1,54 x 0,64 x 0,80 m
▨	14,57 m <sup>2</sup>
⊕	4,54 x 3,64 m
HIC	0,80 m
NORM	EN 16630:2015-06 EN 1176-1:2017-12

Galvanized Low bars

**Set: 1xSW-37**



S	PM, MM, I
+	1,69 x 0,49 x 1,30 m
▨	14,42 m <sup>2</sup>
⊕	4,69 x 3,49 m
HIC	1,20 m
NORM	EN 16630:2015-06 EN 1176-1:2017-12

Slanted bench "Crunches"

**Set: 1xSW-4 + 1xSW-27**



S	PM, MM, I
+	2,50 x 0,16 x 2,50 m
▨	15,44 m <sup>2</sup>
⊕	4,00 x 3,16 m
HIC	1,40 m
NORM	EN 16630:2015-06 EN 1176-1:2017-12

High bars

**Set: 3xSW-2 + 2xSW-19**



S	PM, MM, I
+	1,60 x 0,16 x 2,50 m
▨	17,22 m <sup>2</sup>
⊕	4,60 x 4,16 m
HIC	1,50 m
NORM	EN 16630:2015-06 EN 1176-1:2017-12

Gymnastic rings

**Set: 2xSW-2 + 1xSW-40**

## Single devices



S	PM, MM, I
+	0,76 x 0,54 x 1,90 m
▨	11,38 m <sup>2</sup>
⊞	3,76 x 3,54 m
HIC	1,54 m
NORM	EN 16630:2015-06 EN 1176-1:2017-12

Handrails with adjustable height

**Set: 1xSW-4 + 1xSW-30**



S	PM, MM, I
+	0,60 x 4,00 x 0,30 m
▨	23,25 m <sup>2</sup>
⊞	3,60 x 7,00 m
HIC	00,0 m
NORM	EN 16630:2015-06 EN 1176-1:2017-12

Battle rope

**Set: 1xSW-6 + 1xSW-50**



S	PM, MM, I
+	2,13 x 0,16 x 2,50 m
▨	19,40 m <sup>2</sup>
⊞	3,60 x 7,00 m
HIC	2,00 m
NORM	EN 16630:2015-06 EN 1176-1:2017-12

Net Wall

**Set: 1xSW-2\_2 + 1xSW-41**



S	PM, MM, I
+	0,37 x 0,16 x 1,90 m
▨	00,0 m <sup>2</sup>
⊞	0,00 x 0,00 m
HIC	0,00 m
NORM	EN 16630:2015-06 EN 1176-1:2017-12

Information board

**Set: 1xSW-4 + 1xSW-52**



## Some our projects











## CONTACT WITH US



STARMAX Marek Starczewski  
Rycerska 3 St.  
83-050 Bakowo, POLAND  
[www.starmax.com.pl](http://www.starmax.com.pl)  
[export@starmax.com.pl](mailto:export@starmax.com.pl)

**+48 884 000 884**  
Playgrounds & Workout equipments

**+48 600 250 245**  
Outdoor gums & Trampolines

**+48 602 323 104**  
Graphic projects